

CS200, CS230N METAL CUTTING CIRCULAR SAWS

Quickly cut metals such as steel, stainless, aluminum and others using TCT dry cut blades for accurate, burr-free cuts.

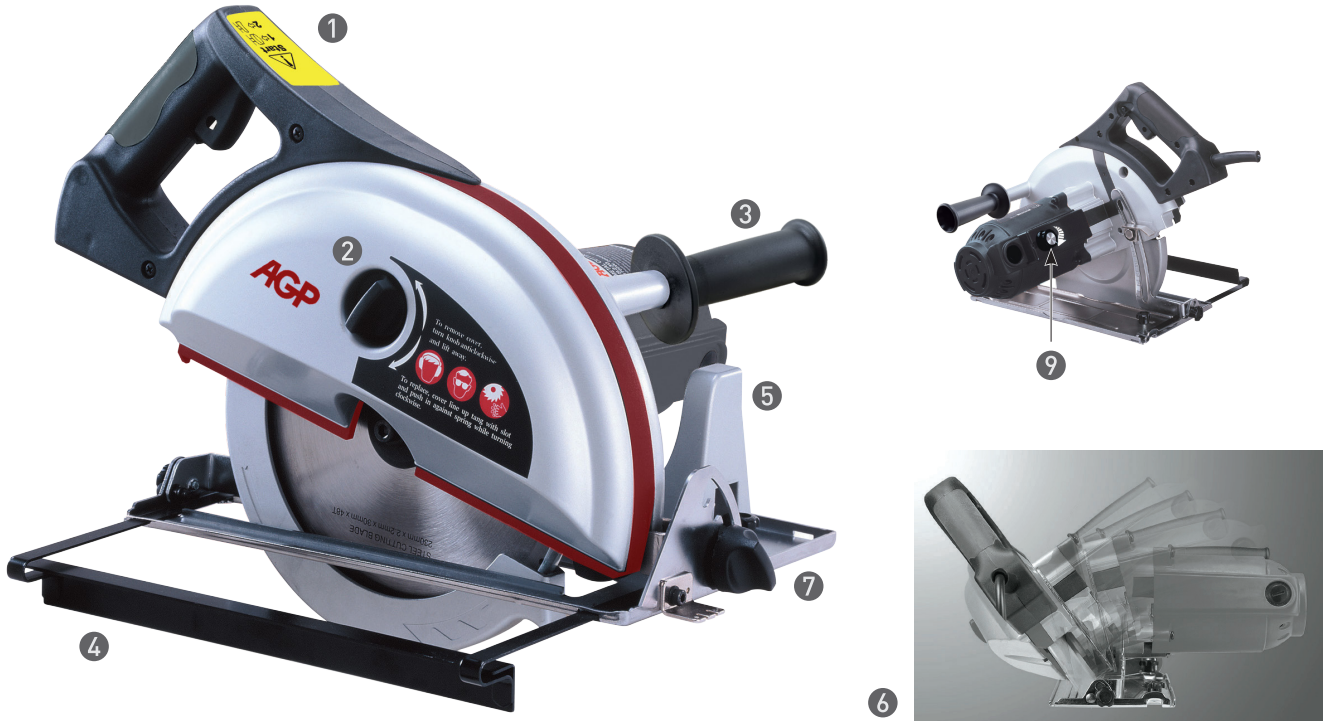

Features

1. Handle is in the same plane with the blade for ideal balance, control, and ease of pushing.
2. Bayonet mount locking knob for Blade Cover for quick clearing of swarf.
3. Side Handle affixed to the base gives superior stability during bevel cuts.
4. Adjustable Rip Fence.
5. Base Mount Bracket for Side Handle.
6. Bevels up to 45°.
7. Tool-Free Bevel Changes with 5 Detents.
8. Quick, Tool-Free Depth Adjustment.
9. Speed Control. (optional)

Standard/ Optional Accessories See p. 121

Model	CS200	CS230N
Power Input	1700 W	
Voltage, Frequency	220-240 V~ 50-60 Hz or 110-120 V~ 50-60 Hz	
No Load (Rated Load) Speed	3700 (2200) min ⁻¹	2200 (1320) min ⁻¹
Bevels	0° to 45°	
TCT Saw Blade	200 mm (8")	230 mm (9")
Arbor	30 mm (1-3/16") or 25.4 mm (1")	
Cutting Capacities	Straight Cut: 67 mm (2-5/8") 45° Bevel: 42 mm (1-5/8")	Straight Cut: 80 mm (3-1/4") 45° Bevel: 56 mm (2-3/16")
Soft Start & Overload Protection	With	
Dimensions (LxWxH)	368 x 284 x 330 mm	383 x 301 x 360 mm
Weight	6.3 kg (13.6 lb)	7.1 kg (15.6 lb)
Characteristics / Certification		

CS320 METAL CUTTING CIRCULAR SAW

PATENTED

Quickly cut metals such as steel, stainless, aluminum and others using 320 mm TCT dry cut blades for accurate, burr-free cuts. Extra deep 121 mm depth of cut and optional guide rail make it especially suited to cutting thick, corrugated sandwich panels.

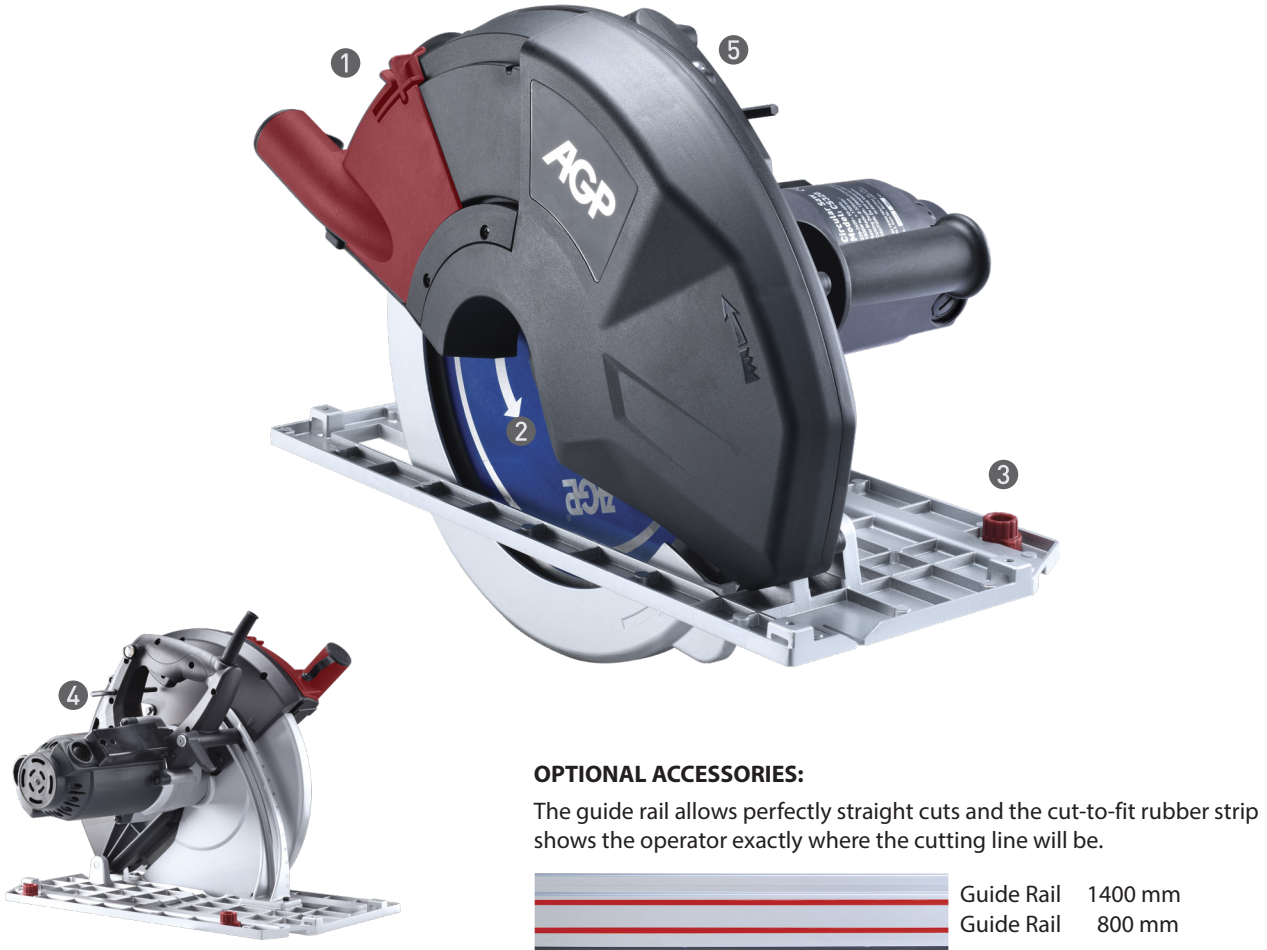

OPTIONAL ACCESSORIES:

The guide rail allows perfectly straight cuts and the cut-to-fit rubber strip shows the operator exactly where the cutting line will be.

	Guide Rail	1400 mm
	Guide Rail	800 mm

Features

1. Unique, patented dust chamber cover opens and snaps closed in seconds. Highly effective dust and debris collection.
2. Large cutting capacity provided by the 320 mm metal cutting blade. A full 121 mm depth of cut when mounted on a guide rail.
3. Guide clearance adjustor.
4. Kicker Lever for opening the lower blade guard on thick, soft-cored sandwich panels.
5. LED Load Indicator enables maximum efficiency.

Standard/ Optional Accessories See p. 121

Model	CS320
Power Input	1800 W (220-240 V), 1700 W (110-120 V)
Voltage, Frequency	220-240 V~ 50-60 Hz or 110-120 V~ 50-60 Hz
No Load (Rated Load) Speed	1700 (1020) min ⁻¹
Rated Blade Diameter	320 mm
Arbor Hole Diameter	25.4 mm (1")
Max. Cutting Depth	128 mm (121 mm on Guide Rail)
Soft Start & Overload Protection	With
Dimensions (LxWxH)	500 x 342 x 355 mm
Weight	8.4 kg (18.5 lb)
Characteristics / Certification	

DRC355 DRY-CUT METAL SAW

Quickly cut metals such as steel, stainless, aluminum and others using 355 mm (14") TCT dry cut blades for accurate, burr-free cuts. Up to 3 times faster than conventional abrasive wheel cut-off saws. Can also perform left and right miter cuts.



Model	DRC355		
Power Input	2200 W		
Voltage, Frequency	220-240 V~ 50-60 Hz or 110-120 V~ 50-60 Hz		
No Load Speed	1300 min ⁻¹		
Rated Load Speed	780 min ⁻¹		
Rated Blade Diameter	355 mm (14")		
Max. Cutting Capacities	90°	Round Pipe	132 mm
		Square Stock	120 mm(W) x 120 mm(H)
		Rectangular Stock	180 mm(W) x 100 mm(H)
	Right Hand Miter		
	45°	Round Pipe	105 mm
		Square Stock	90 mm(W) x 90 mm(H)
		Rectangular Stock	90 mm(W) x 120 mm(H)
	Left Hand Miter		
	25°	80 mm(W) x 120 mm(H)	
	30°	90 mm(W) x 120 mm(H) C-clamp required	
	35°	80 mm(W) x 120 mm(H) C-clamp required	
	45°	70 mm(W) x 120 mm(H) C-clamp required	
Arbor	25.4 mm (1")		
Soft Start	With		
Dimensions (LxWxH)	680 mm x 360 mm x 580 mm		
Weight	23.5 kg (51.7 lb)		
Characteristics / Certification			



V-Jig Block



Lever Clamp

Features

1. High-stability cast alloy base.
2. Fence with scale swivels 45° in both directions with quick detents for the popular miter angles: 0°-15°-30°-45° left and right.
3. The locking holes may be used, if desired, for extra secure fence locking.
4. Two-piece Lower Blade Guard.
5. Tool-Free Fence Lock.
6. Quick-Lock Vise with Speed Crank.
7. Chip Tray.

Standard/ Optional Accessories See p. 121

Circular Saw Accessories

CS200, CS230N Metal Cutting Circular Saws

Standard Accessories	
Side Handle	
M6 Hex Key	
Optional Accessories	Part Number
Speed Control Device	
TCT Saw Blade	See p. 120



a Lever Clamp

DRC355 Dry-Cut Metal Saw

Standard Accessories	
M4 Hex Key	
M6 Hex Key	
M8 Hex Key	
Optional Accessories	Part Number
Lever Clamp	305-00179-000-001
a Safety Goggles	305-00056-000-001
V-Jig Block	201-0030-00902-001
b TCT Saw Blade	See p. 120



b V-Jig Block

CS320 Metal Cutting Circular Saw

Standard Accessories	
M6 Hex Key	
Side Handle	
Optional Accessories	Part Number
TCT Saw Blades (Excellent for sandwich panel)	See p. 120
a Lever Clamp	305-010179--000-001
c Guide Rail Connector	0299-0106-00000-001
d Guide Rail 1400 mm	0299-0065-00164-001
d Guide Rail 800 mm	0299-0065-00164-002



c Guide Rail Connector



d Guide Rail

Circular Saw Accessories

TCT Saw Blades

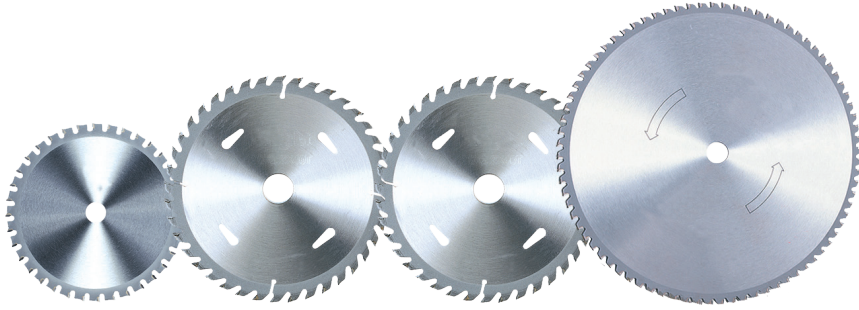

TCT Saw Blades for Wood:											Part Number
Application	Dia. (mm)	Kerf. (mm)	Bore (mm)	Teeth	Plate (mm)	Hardness HRA	Carbide (mm)		Hook Angle	Grind	
							Thick	Length			
DS1600	160	2.8	20	28	2.0	92	2	6.5	0°	ATB	305-00036-000-003
GP255, GP255S	255	2.6	25.4	40	1.8	92	1.6	5.5	20°	ATB	305-00036-000-016
GP255, GP255S	255	2.8	30	40	1.8	92	1.6	5.5	0°	ATB	305-00036-000-017

TCT Saw Blades for Aluminium:											Part Number
Application	Dia. (mm)	Kerf. (mm)	Bore (mm)	Teeth	Plate (mm)	Hardness HRA	Carbide (mm)		Hook Angle	Grind	
							Thick	Length			
DRC355	355	2.4	25.4	80	2.0	91	1.9	6.2	0°	TCG	305-00036-000-020
GP255, GP255S	255	2.6	25.4	100	1.8	91	1.6	5.5	20°	TCG	305-00036-000-058
GP255, GP255S	255	2.6	30	100	1.8	91	1.6	5.5	0°	TCG	305-00036-000-066

TCT Saw Blades for Steel:											Part Number
Application	Dia. (mm)	Kerf. (mm)	Bore (mm)	Teeth	Plate (mm)	Hardness HRA	Carbide (mm)		Hook Angle	Grind	
							Thick	Length			
CS200	203	2.0	20	40	1.6	90.8	1.6	5.5	0°	TCG	305-00036-000-008
CS230N	230	2.0	25.4	48	1.6	90.8	1.6	5.5	0°	TCG	305-00036-000-029
CS320	320	2.2	25.4	80	1.8	90.8	1.9	6.2	0°	TCG	305-00036-000-054
DRC355	355	2.4	25.4	80	2.0	90.8	1.9	6.2	0°	TCG	305-00036-000-001

TCT Saw Blades for Stainless Steel:											Part Number
Application	Dia. (mm)	Kerf. (mm)	Bore (mm)	Teeth	Plate (mm)	Hardness HRA	Carbide (mm)		Hook Angle	Grind	
							Thick	Length			
CS200	203	1.8	20	52	1.4	90.8	1.6	5.5	7°	TCG	305-00036-000-037
CS230N	230	1.8	25.4	60	1.4	90.8	1.6	5.5	10°	TCG	305-00036-000-039
DRC355	355	2.4	25.4	90	2.0	90.8	1.9	6.2	10°	TCG	305-00036-000-021

Note: Tooth Grind Patterns

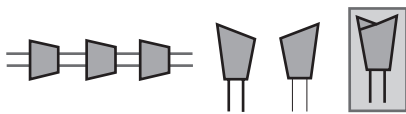

ATB (Alternate Top Bevel)
Ideal for cross cutting and ripping in wood

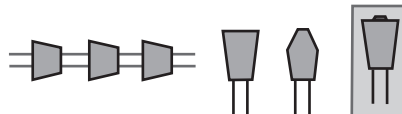

TCG (Triple Chip Grind)
Ideal for metal cutting blades. Gives long sharp life in hard materials. The pointed tooth cuts narrow kerf, then the flat-top raker tooth widens the kerf and clears out chips.

T14 TAPPER

A convenient tool for quickly tapping a series of through holes or blind holes up to M16 (5/8"). The auto-reverse gearbox mechanism makes tapping a super fast operation.



Features

1. 2-Jaw Universal Tapping Chuck is self-centering and grips any size tap from M6 up to M16.
2. Unique, purpose-built gearbox makes tapping fast, efficient, and uniquely controllable. Press down for low-g geared clockwise rotation. Pull back for high-g geared counterclockwise rotation. Neutral in the center.
3. Ergonomic handle makes it easy to hold the tool straight.
4. Sprung Swivel Joint minimizes possibility of tap breakage.
5. Depth Stop for blind hole tapping.
6. Long Side Handle for excellent control.

Model	T14	
Power Input	450 W	
Voltage, Frequency	220-240 V~ 50-60 Hz or 110-120 V~ 50-60 Hz	
No Load (Rated Load) Speeds	Forward	280 (182) min ⁻¹
	Reverse	680 (442) min ⁻¹
Tapping Capacity	Steel	14 mm (9/16")
	Aluminum	16 mm (5/8")
Dimensions (LxWxH)	400 x 80 x 200 mm	
Weight	2.7 kg (5.9 lb) (Not including side handle 0.45 kg (1lb))	
Characteristics / Certification		

Standard Accessories
Side Handle
M4 Hex Key
Depth Stop
Optional Accessories
a Safety Clutch

EB6T ELECTRIC BEVELER

Shape beveler for 45 degree bevels with up to 6 mm chamfer height. Excellent for following curved shapes, beveling cut-outs and countersinking holes over 30 mm.

Uses 3 standard square carbide inserts. Can also perform radiused edges with optional inserts and 30 degree bevels with optional tool holder.



OPTIONAL ACCESSORIES:

Replacement Carbide Inserts (Box of 10)



- Straight Bevel
- R2.5 Radius
- R3.5 Radius
- R4 Radius

Optional Radius Tool Holder

Features

1. Motor with variable constant speed electronics for consistent surface results.
2. Variable Speed Wheel for setting the best speed with different materials.
3. Square Carbide Inserts. 3 Indexable square carbide inserts: ISO SEMT13T3.
4. Tool-Free Bevel Height Setting with Micrometer Scale.
5. Bevel Height Scale.
6. Adjustable Dial Ring Support Deck.

Standard/ Optional Accessories See p. 127

Model	EB6T
Power input	1100 W
Voltage, Frequency	220-240 V~ 50-60 Hz or 110-120 V~ 50-60 Hz
*No Load Speeds	3000 - 6000 min ⁻¹
Bevel Angle	45° (optional 30°)
Max. Chamfer Height	6 mm (at 45°) / 6.1 mm (at 30°)
Max. Bevel Width	8.5 mm (at 45°) / 6.9 mm (at 30°)
Min. Ø For Inside Bevels	30 mm
Dimensions (LxWxH)	308 x 344 x 273 mm
Weight	4.5 kg (9.9 lb)

Characteristics / Certification	
---------------------------------	--

* Due to the constant speed design, the no load and the rated load speeds are roughly the same.

EB12 ELECTRIC BEVELER

Heavy duty shape beveler for 45 degree bevels with up to 11.0 mm chamfer height. Excellent for beveling straight lines, curved shapes, cut-outs and countersinking holes over 30 mm. Uses 6 square carbide inserts. Can also perform 30 and 37.5 degree bevels with optional tool holders.



OPTIONAL ACCESSORIES:

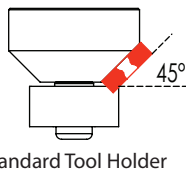
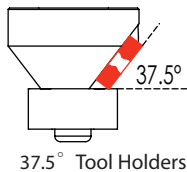
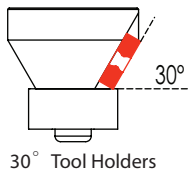

Replacement Carbide Inserts (Box of 10)



Straight Bevel

Features

1. Speed Control Thumb Wheel. Variable Electronic Constant Speed Circuitry maintains speed under load.
2. Precision Chamfer Height Adjustment with Dial Scale.
3. 6 Carbide Insert Tool Holder Set.

Standard/ Optional Accessories See p. 127

Model	EB12
Power Input	1800 W
Voltage, Frequency	220-240 V~ 50-60 Hz or 110-120 V~ 50-60 Hz
* No Load Speeds	2300 - 6500 min ⁻¹
Speed Wheel Settings	1: 2300 / 2: 2600 / 3: 3700 / 4: 4800 / 5: 5800 / 6: 6500 min ⁻¹
Standard Bevel Angle	45°
Max. Chamfer Height	11 mm (at 45°) / 12 mm (at 37.5°) / 11.7 mm (at 30°)
Max. Bevel Width	15.6 mm (at 45°) / 15.1 mm (at 37.5°) / 13.5 mm (at 30°)
Min. Ø For Inside Bevels	30 mm
Soft Start & Overload Protection	With
Dimensions (LxWxH)	308 x 344 x 273 mm
Weight	6.4 kg (14 lb)
Characteristics / Certification	

* Due to the constant speed design, the no load and the rated load speeds are roughly the same.

EB24R ELECTRIC BEVELER

A plate beveler for angles from 0° to 60° with a maximum land width of 21mm with facing off and pipe beveling capability from 150 mm to 350 mm.

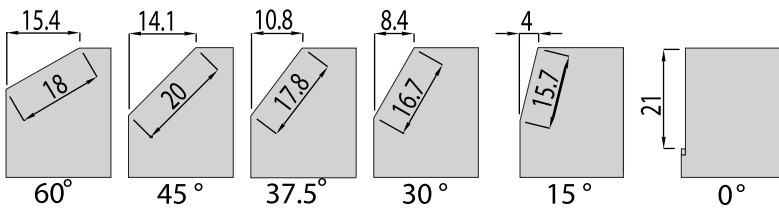

OPTIONAL ACCESSORIES:

Replacement Carbide Inserts (Box of 12)



Model	EB24R	
Power Output	1.1 kW (1.5 HP)	
Voltage, Frequency	220-240 V~ 50-60 Hz or 110-120 V~ 50-60 Hz	
No Load Speed	60 Hz: 3600 min ⁻¹ , 50 Hz: 3000 min ⁻¹	
Angular Adjustment	Angle	Max. Bevel Width
	60°	18 mm
	45°	20 mm
	37.5°	17.8 mm
	30°	16.7 mm
	15°	15.7 mm
	0°	21 mm
Pipe beveling	150-350 mm (Standard), 300-600 mm (Optional)	
Dimensions (LxWxH)	475 x 296 x 247 mm	
Weight	19.3 kg (42.5 lb)	
Characteristics / Certification		

Features

1. AC Induction Motor for steady speed, low noise, and long life.
2. Tool holder with 12 carbide inserts (ISO type SPKN 1203 0.8) Bevel widths on straight and round materials.
3. Angular Adjustment Screw with angular adjustment from 0-60°
4. Depth-adjuster knob.
5. Depth Lock Screw.
6. Chamfer Height Scale.
7. Rollers for smooth operation.

Standard/ Optional Accessories See p. 127

Electric Beveler Accessories

EB6T Electric Beveler

Standard Accessories	
Torx Wrench T15	
Hook Spanner Wrench	
Spindle Lock Bar	
45° Tool Holder Set	
Square Carbide Inserts x3	
Plastic Carry Case	
Optional Accessories	Part Number
30° Tool Holder Set	0299-0142-00000-008
Square Carbide Inserts (Box of 10)	305-00051-000-007
Radius 2.5 Tool Holder Set	305-00051-000-008
Radius 3.5 Tool Holder Set	305-00051-000-009
Radius 4.0 Tool Holder Set	305-00051-000-010
R2.5 mm inserts x10	0299-0142-00000-009
R3.5 mm inserts x10	0299-0142-00000-010
R4.0 mm inserts x10	0299-0142-00000-011

EB12 Electric Beveler

Standard Accessories	
45° Tool Holder Set	
Square Carbide Inserts x6	
Torx Wrench T15	
Hex. Wrench M6	
Hook Spanner Wrench	
Spindle Lock Bar	
Plastic Carry Case	
Optional Accessories	Part Number
30° Tool Holder Set	0299-0142-00000-006
37.5° Tool Holder Set	0299-0142-00000-007
Square Carbide Inserts (Box of 10)	305-00051-000-006

EB24R Electric Beveler

Standard Accessories	
Milling Disc	
Square Carbide Inserts x12	
L-Hex. Wrench M8	
L-Hex. Wrench M3	
M 22 Open End Wrench	
M 32 Combination Wrench	
M27 x M24 Double Open End Wrench	
Zero Degree Milling Receiver	
Bevel Milling Receiver	
Blow Molded Case	
Optional Accessories	Part Number
Large Table Plate (for pipes 300-600 mm)	302-04150-907-004
Small Table Plate (for pipes 150-350 mm)	302-04150-907-003
Replacement Carbide Inserts (Box of 12)	305-00052-000-001

SG6 150mm STRAIGHT GRINDER

Heavy duty straight grinder with variable constant speed electronics for outstanding performance and even finish.



■ Polishing mode



5 Taper Mandrel Arbor

Features

1. Variable Electronic Constant Speed Circuitry maintains speed under load.
2. Speed Control Thumb Wheel.
3. Adjustable guard.
4. Hand Grip.
5. Taper Mandrel Arbor.

Model	SG6
Power Input	1500 W (220-240 V), 1300 W (110-120 V)
Voltage, Frequency	220-240 V~ 50-60 Hz or 110-120 V~ 50-60 Hz
* No Load Speeds	1600 - 4800 min ⁻¹
Spindle	M14 (w/ 20 mm Tool Holder)
Max. Wheel Diameter	150 mm (6")
Soft Start & Overload Protection	With
Dimensions (LxWxH)	566 x 80 x 96 mm
Weight	3.4 kg (6.6 lb)
Characteristics / Certification	

Standard Accessories
Face Spanner Wrench
Taper Mandrel Arbor
Wrench M17
Wrench M22
Hex Key M5
Optional Accessories
Wheel

* Due to the constant speed design, the no load and the rated load speeds are roughly the same.

WS760 WRAPAROUND TUBE SANDER / POLISHER

A specialized tool for fast and easy finishing of tube forms. Contacts up to 270 degrees of the tube at a time. Easy belt changes for different grits and grades of belt.



Features

1. Variable Electronic Constant Speed Circuitry maintains speed under load.
2. Speed Control Thumb Wheel.
3. High stability pulleys prevent belts from coming off in operation.
4. Tool-free belt changing for quick changes between different grits.
5. Self-tensioning arm.
6. High stability drive pulley.

Model	WS760
Power Input	1200 W (220-240 V), 850 W (110-120 V)
Voltage, Frequency	220-240 V~ 50-60 Hz or 110-120 V~ 50-60 Hz
* No Load Speeds	1600 - 3200 min ⁻¹
Surface Speed	3~12 m/s
Max. Belt (L) x (W)	760 mm x 40 mm
Max. Pipe Diameter	180 mm
Max. Polishing Deg.	270°
Soft Start & Overload Protection	With
Dimensions (LxWxH)	530 x 370 x 215 mm
Weight	3.1 kg (6.8 lb)
Characteristics / Certification	

Standard Accessories	Part Number
Side Handle	
Surface Conditioning Belt (40 x 760 mm)	305-00043-000-002
Sandpaper Belt x5 #120 grit (40 X 760 mm)	305-00045-000-009
Sandpaper Belt x5 #220 grit (40 X 760 mm)	305-00045-000-010
Face Spanner Wrench	
Plastic Carry Case	

* Due to the constant speed design, the no load and the rated load speeds are roughly the same.

DP100 DRUM SANDER / POLISHER

An extremely versatile linear sander / polisher system. Go all the way from rough sanding up through mirror polishing as well as create effects like brushed finishes.



Features

1. Cast aluminum front handle bracket for better balance and stability.
2. Variable Electronic Constant Speed Circuitry maintains speed under load.
3. Inflatable rubber sanding drum conforms to the surface (pump included) Can fit:
 - Sanding sleeves in various grits
 - Fine sanding sponge sleeves
 - Surface conditioning (fleece) sleeves
4. Optional Screw Type Mounting Nut fits flush and allows the drum to go all the way into corners.
5. Tool-Free Arbor.
6. Speed Control Thumb Wheel.

Model	DP100
Power Input	1200 W (220-240 V), 850 W (110-120 V)
Voltage, Frequency	220-240 V~ 50-60 Hz or 110-120 V~ 50-60 Hz
* No Load Speeds	1500 - 2800 min ⁻¹
Max. Wheel Diameter	100 mm
Max. Wheel Width	100 mm
Arbor	19 mm double keyed x 100 mm long
Soft Start & Overload Protection	With
Dimensions (LxWxH)	394 x 198 x 195 mm
Weight	3.5 kg (7.7 lb)
Characteristics / Certification	

* Due to the constant speed design, the no load and the rated load speeds are roughly the same.

Surface Conditioning Flap Wheel



Drive Pulley for Belts



■ Inflatable Rubber Sanding Drum



a Inflatable Rubber Sanding Drum



b Air Pump



c Sandpaper Sleeve



h Surface Conditioning Flap Wheel

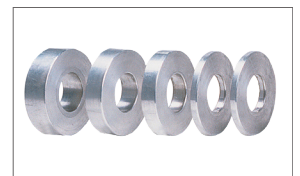

i Arbor Spacer Discs

■ Surface Conditioning Flap Wheel

■ Drive Pulley for Belts

(All belts with 45 degree slit for opening and closing)



d Drive Pulley for Belts

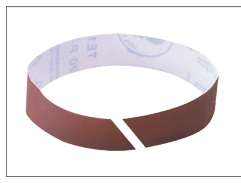

e Sandpaper Belt



f Surface Conditioning Belt



g Hook & Loop Belt Closing Straps

Standard Accessories	
Plastic Carry Case	
Optional Accessories	Part Number
a Inflatable Rubber Sanding Drum	0299-0016-00000-001
b Air Pump	305-00041-004-001
c Surface Conditioning Sleeve (100 x 292 mm)	305-00043-000-001
c Sandpaper Sleeve #60	305-00045-000-001
c Sandpaper Sleeve #100	305-00045-000-002
c Sandpaper Sleeve #180	305-00045-000-003
d Drive Pulley for Belts	303-01073-005-001
e Sandpaper Belt #120 Grit (40 x 600 mm)	305-00048-000-001
f Surface Conditioning Belt (40 x 600 mm)	305-00046-000-001
g Hook & Loop Belt Closing Straps (30 x 700 mm)	305-00049-000-001
h Surface Conditioning Flap Wheel (100 x 100 x 19 mm)	305-00042-000-001
i Arbor Spacer Discs (35 x 19 x 5 mm)	305-01021-004-002

DB32 DIGITAL BENDING MACHINE

A portable tubing bender with unique digital LCD degree display. Preset the desired angle up to 190° in tubing up to 1-3/8". The digital control allows fine tuning of the bend and repeatable results.

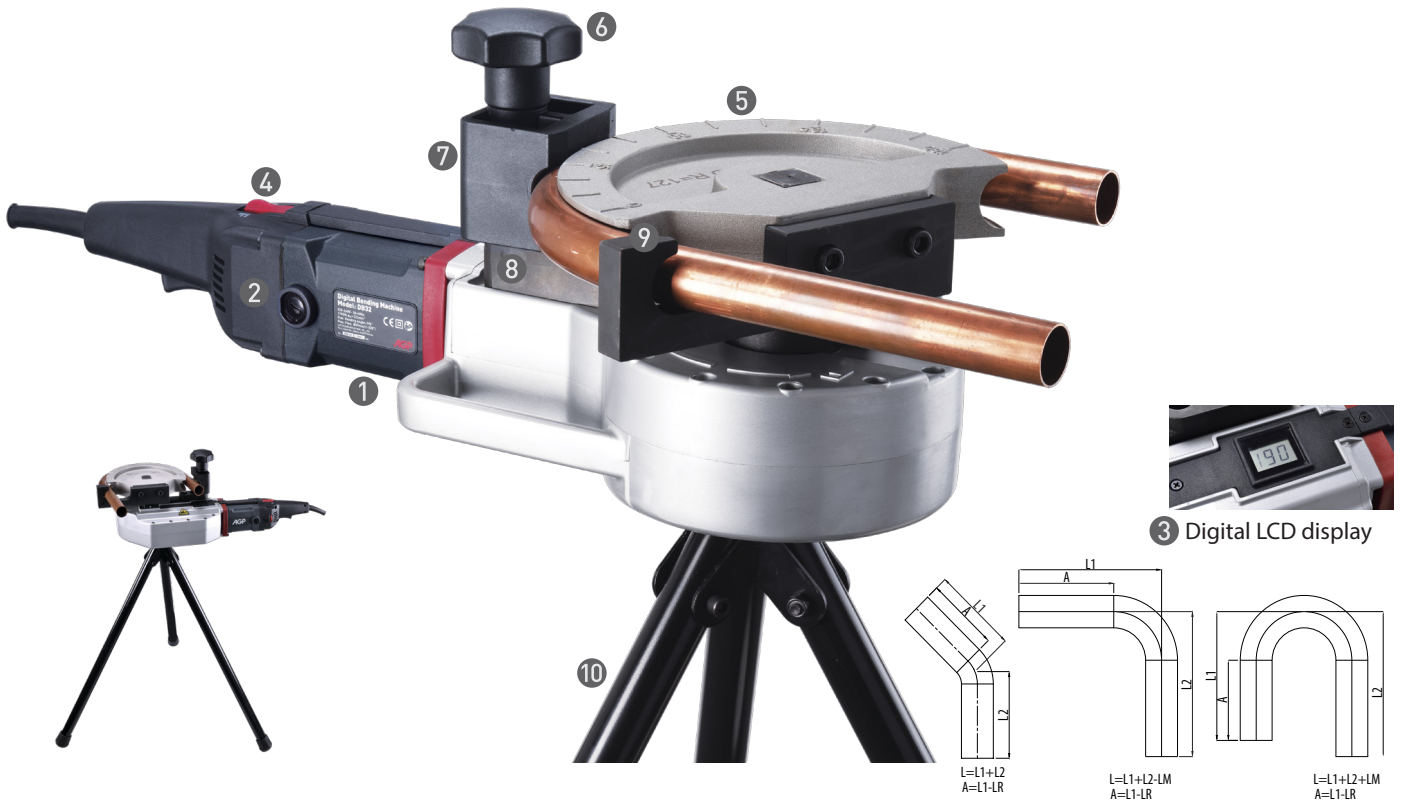

OPTIONAL ACCESSORIES:

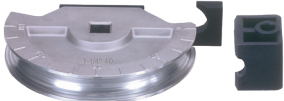

Bending Former & Bending Shoe

Bending Former		Part Number	Bending Shoe		Part Number
1.	5/8" R=4D	0299-0045-00000-001	5/8"	303-01220-004-001	
2.	3/4" R=4D	0299-0045-00000-002	3/4"	303-01220-004-002	
3.	7/8" R=4D	0299-0045-00000-003	7/8"	303-01220-004-003	
4.	1" R=4D	0299-0045-00000-004	1"	303-01220-004-004	
5.	1-1/8" R=4D	0299-0045-00000-005	1-1/8"	303-01220-004-005	
6.	1-1/4" R=4D	0299-0045-00000-006	1-1/4"	303-01220-004-006	
7.	1-3/8" R=3.6D	0299-0045-00000-007	1-3/8"	303-01220-004-007	

Features

- 1700 W motor with constant speed.
- Thumbwheel for setting the desired degree of bend.
- Digital LCD display.
- Easy to use reversing switch.
- Bending Former with gradation markings.
- Shoe pivot bolt.
- Bending shoe.
- Shoe bracket.
- Driver hook.
- Tripod.

Model	DB32
Power Input	1700 W
Voltage, Frequency	220-240 V~ 50-60 Hz or 110-120 V~ 50-60 Hz
No Load Speed	3.5 min ⁻¹
Max. Capacity	1-3/8"
Soft Start	With
Dimensions (LxWxH)	630 x 230 x 183 mm
Weight	14 kg (30.9 lb)
Characteristics / Certification	

Standard Accessories	Part Number
Tripod	0299-0044-00000-001
Velcro Strap	305-00150-000-001
Optional Accessories	
Bending Former & Bending Shoe	

Size	Material	R(mm)	45°		90°		180°	
			L _s (mm)	L _m (mm)	L _s (mm)	L _m (mm)	L _s (mm)	L _m (mm)
5/8"(15.88mm)		64	25	-	69	35	66	52
3/4"(19.05mm)		77	30	-	79	35	79	63
7/8"(22.22mm)		88	35	-	92	48	92	96
1"(25.4mm)		102	39	-	103	58	103	112
1-1/8"(28.58mm)		115	45	-	118	55	118	118
1-1/4"(31.75mm)		127	50	-	130	71	130	135
1-3/8"(34.9mm)		123	48	-	126	51	126	149

HC127 HOLE CUTTING DRILL

A convenient tool for quickly drilling perfectly centered and perpendicular holes up to 127 mm diameter in pipes from 1-1/4" to 8-1/4". Excellent for installing mechanical tee fittings, pipe saddles, etc.



Features

1. Good balance for carrying.
2. The quick adjustable tool-free Crank Handle can mount on either side.
3. Chain Vise Clamping System quickly mounts machine onto 1-1/4" to 8-1/4" diameter pipe. (32 mm-203 mm)
4. Built-in Bubble Levels for multiple hole alignment.

Model	HC127
Power Input	1100 W
Voltage, Frequency	220-240 V~ 50-60 Hz or 110-120 V~ 50-60 Hz
No Load (Rated Load) Speed	130 (85) min ⁻¹
Max. Cutting Capacity (Hole Cutter)	127 mm
Pipe Mounting Capacity	32 mm-203 mm (600 mm w/ optional Long Chain Set)
Drill Chuck Capacity	16 mm (5/8") shank
Over Load Protection	With
Weight	14.5 kg (31.9 lb) Not including Crank Handle
Characteristics / Certification	

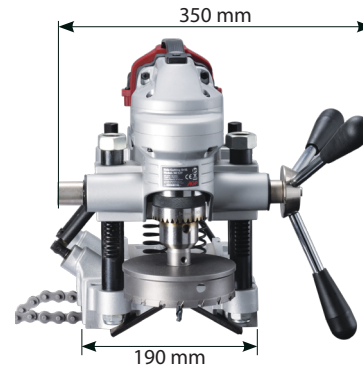
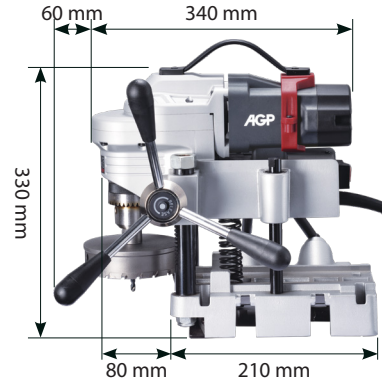

TCT HOLE CUTTERS (FOR MODEL HC127) 25 mm DEPTH



Diameter (mm)	Part Number
60	305-03346-000-037
65	305-03346-000-038
70	305-03346-000-039
75	305-03346-000-040
80	305-03346-000-041
85	305-03346-000-042
90	305-03346-000-043
95	305-03346-000-044
100	305-03346-000-045
105	305-03346-000-046
110	305-03346-000-047
115	305-03346-000-048
120	305-03346-000-049
125	305-03346-000-050
127	305-03346-000-051

***Note:** Bi-metal hole saws or twist drills recommended for sizes below 60 mm

Standard Accessories	
16 mm (5/8") Chuck & Chuck Key	
Crank Handle Set	
Optional Accessories	Part Number
Long Chain Set (for pipes up to 600 mm diameter)	305-00035-000-002

RS26 RECIPROCATING SAW FOR PIPES

A reciprocating saw purpose-built for making perfectly square cuts on pipes up to 8" diameter. Orbital reciprocating mechanism and variable constant speed allow the fastest possible results.



Optional **2-in-1 vise**. On one side there is a **chain clamp** for 1/2" up to 8" pipes. On the other side is a **Quick-Release Vise**. For pipe cutting, the vise gives 4 times the leverage and a perfect 90 degree cut.



Quick-Release Vise side of the optional 2-in-1 Vise for smaller diameters.



Chain Vise side of the optional 2-in-1 Vise for larger diameters.

Features

1. High-impact reciprocating mechanism with aggressive orbital action.
2. Speed Control Thumb Wheel.
3. Electronic Constant Speed Circuitry maintains speed under load.
4. Soft-grip boot on gearcase.
5. Ratchet Handle for quick, tool-free clamping.
6. Quick-Release Chain Vise. (Standard)

Model	RS26
Power Input	1500 W
Voltage, Frequency	220-240 V~ 50-60 Hz or 110-120 V~ 50-60 Hz
* No Load Speeds	1000 - 2100 min ⁻¹
Stroke	26 mm (1")
Max. Capacity	203 mm (8")
Speed Control	With
Soft Start & Overload Protection	With
Dimensions (LxWxH)	491 x 94 x 108 mm
Weight	4.35 kg (10 lb)
Characteristics / Certification	

OPTIONAL ACCESSORIES:

Blade 290 mm



Standard Accessories

Hex. Wrench M4

Quick-Release Chain Vise

Optional Accessories	Part Number
2-in-1 Vise	0299-0013-00004-001
Blade 290 mm	305-00036-000-033

* Due to the constant speed design, the no load and the rated load speeds are roughly the same.

RS130B RECIPROCATING SAW

A general purpose reciprocating saw with variable constant speed motor.

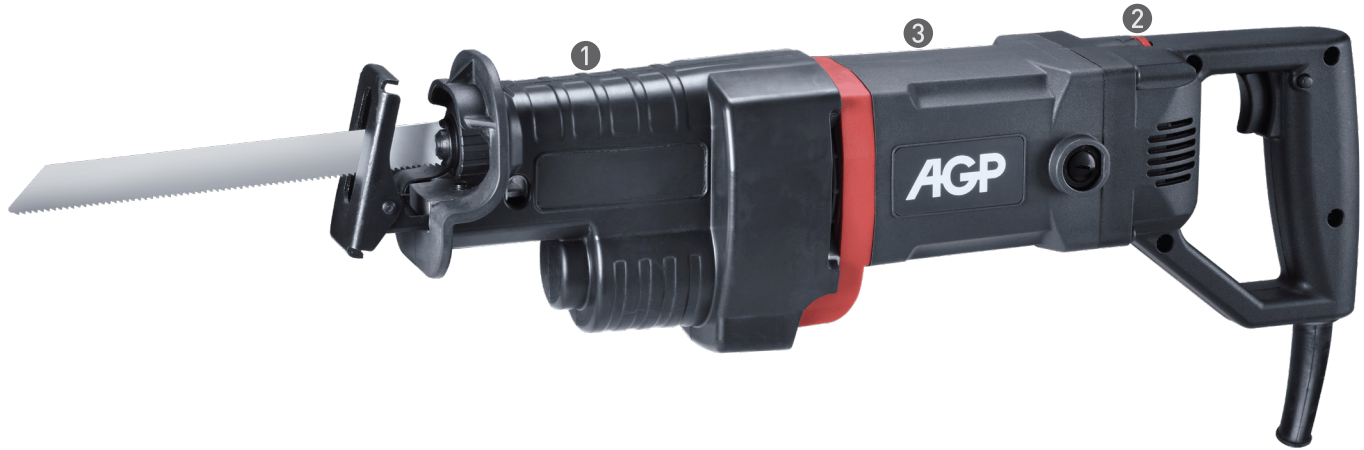

5 Pivoting shoe plate

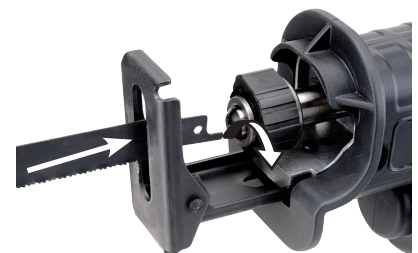

4 Tool-free

Features

1. High-impact reciprocating mechanism.
2. Speed Control Thumb Wheel.
3. Electronic Constant Speed Circuitry maintains speed under load.
4. Tool-free blade change.
5. Pivoting shoe plate.

Model	RS130B
Power Input	1600 W (220 V), 1300 W (110 V)
Voltage, Frequency	220-240 V~ 50-60 Hz or 110-120 V~ 50-60 Hz
* No Load Speeds	1000 - 2800 min ⁻¹
Stroke	26 mm (1")
Max. Capacity	130 mm
Speed Control	With
Soft Start & Overload Protection	With
Quick Release Saw Blade Replacing System	With
Dimensions (LxWxH)	470 x 155 x 97 mm
Weight	3.70 kg (8.14 lb)

OPTIONAL ACCESSORIES:

Blade 190 mm



Standard Accessories

Hex. Wrench M6

Optional Accessories	Part Number
Blade 190 mm	305-00036-000-024

Characteristics / Certification

* Due to the constant speed design, the no load and the rated load speeds are roughly the same.