

# AGP<sup>®</sup>

## Magnetic Core Drill

MD120/4



### Instruction Manual

CE CB  US



## TECHNICAL DATA

Power Input	2000 W (220-240 V), 1700 W (110-120 V)	
Voltage	220-240 V~ 50-60 Hz, or 110-120 V~ 50-60 Hz (See Machine Nameplate)	
* Rated Load Speeds Min <sup>-1</sup>	Speed 1	35 - 120
	Speed 2	70 - 220
	Speed 3	80 - 250
	Speed 4	140 - 450
Capacity	Ø x Depth of Cut (Annular Cutters)	120 mm x 50 mm (4" x 2")
	Ø x Depth of Cut (with Quick-Release Cutter Arbor)	60 mm x 50 mm (2-3/8" x 2")
	Ø of MT3 Twist Drill	32 mm (1-1/4")
	Drill Chuck Capacity	≤ 16 mm (5/8") shank
	Ø of Taps	32 mm (1-1/4")
	Stroke with MT3 Cutting Tools	208 mm (8-3/16")
Magnetic Adhesion	32,000 N	
Overload Protection	Standard	
Net Weight	29.3 kg (64.6 lb)	

\* Due to the constant speed design, the no load and the rated load speeds are roughly the same.

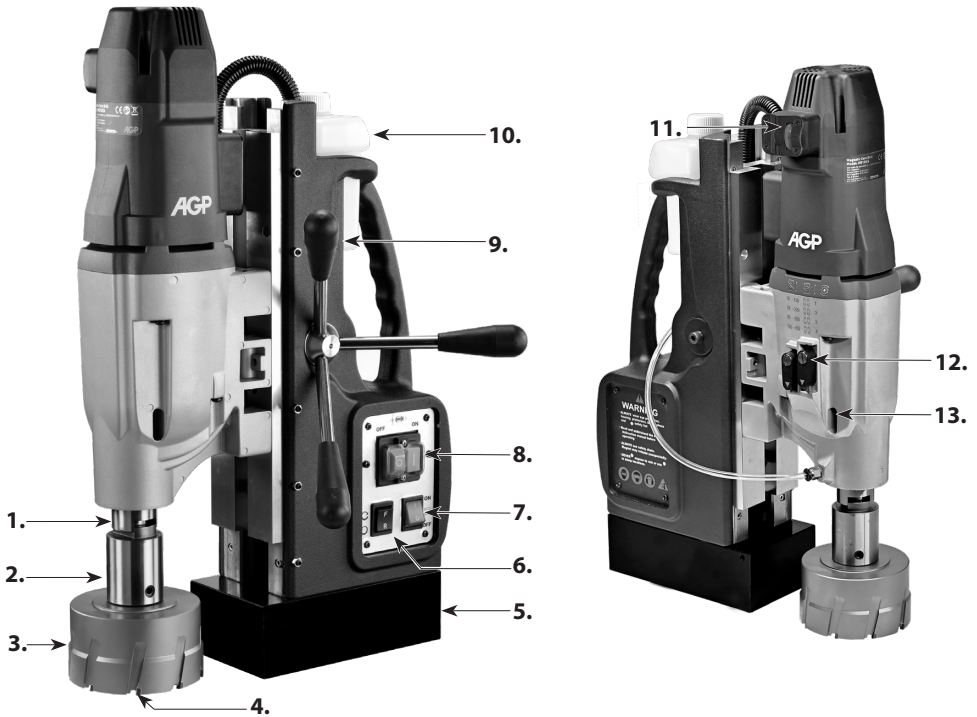

- |                                 |                          |
|---------------------------------|--------------------------|
| 1. Spindle                      | 8. Motor Switch          |
| 2. Arbor                        | 9. Crank Handle          |
| 3. Annular Cutter(Not Included) | 10. Coolant Tank         |
| 4. Pilot Pin (Not Included)     | 11. Variable Speed Wheel |
| 5. Magnet Base                  | 12. Gear Selectors       |
| 6. Reversing Switch             | 13. Ejector Port         |
| 7. Magnet Switch                |                          |

## STANDARD ACCESSORIES

- \* Wrench M8
- \* L-Hex Key M2.5
- \* L-Hex Key M5
- \* Chip Guard Kit
- \* Coolant Tank Kit
- \* Ratchet Strap
- \* Drift

# GENERAL POWER TOOL SAFETY WARNINGS



**WARNING** Read all safety warnings, instructions, illustrations and specifications provided with this power tool. Failure to follow all instructions listed below may result in electric shock, fire and/or serious injury.

Save all warnings and instructions for future reference.

The term "power tool" in the warnings refers to your mains-operated (corded) power tool or battery-operated (cordless) power tool.

## 1) WORK AREA SAFETY

- a. **Keep work area clean and well lit.** Cluttered or dark areas invite accidents.
- b. **Do not operate power tools in explosive atmospheres, such as in the presence of flammable liquids, gases or dust.** Power tools create sparks which may ignite the dust or fumes.
- c. **Keep children and bystanders away while operating a power tool.** Distractions can cause you to lose control.

## 2) ELECTRICAL SAFETY

- a. **Power tool plugs must match the outlet. Never modify the plug in any way. Do not use any adapter plugs with earthed (grounded) power tools.** Unmodified plugs and matching outlets will reduce risk of electric shock.
- b. **Avoid body contact with earthed or grounded surfaces, such as pipes, radiators, ranges and refrigerators.** There is an increased risk of electric shock if your body is earthed or grounded.
- c. **Do not expose power tools to rain or wet conditions.** Water entering a power tool will increase the risk of electric shock.
- d. **Do not abuse the cord. Never use the cord for carrying, pulling or unplugging the power tool. Keep cord away from heat, oil, sharp edges or moving parts.** Damaged or entangled cords increase the risk of electric shock.
- e. **When operating a power tool outdoors, use an extension cord suitable for outdoor use.** Use of a cord suitable for outdoor use reduces the risk of electric shock.
- f. **If operating a power tool in a damp location is unavoidable, use a residual current device (RCD) protected supply.** Use of an RCD reduces the risk of electric shock.

## 3) PERSONAL SAFETY

- a. **Stay alert, watch what you are doing and use common sense when operating a power tool. Do not use a power tool while you are tired or under the influence of drugs, alcohol or medication.** A moment of inattention while operating power tools may result in serious personal injury.
- b. **Use personal protective equipment. Always wear eye protection.** Protective equipment such as a dust mask, non-skid safety shoes, hard hat or hearing protection used for appropriate conditions will reduce personal injuries.
- c. **Prevent unintentional starting. Ensure the switch is in the off-position before connecting to power source and/or battery pack, picking up or carrying the tool.** Carrying power tools with your finger on the switch or energising power tools that have the switch on invites accidents.
- d. **Remove any adjusting key or wrench before turning the power tool on.** A wrench or a key left

attached to a rotating part of the power tool may result in personal injury.

- e. **Do not overreach. Keep proper footing and balance at all times.** This enables better control of the power tool in unexpected situations.
- f. **Dress properly. Do not wear loose clothing or jewellery. Keep your hair and clothing away from moving parts.** Loose clothes, jewellery or long hair can be caught in moving parts.
- g. **If devices are provided for the connection of dust extraction and collection facilities, ensure these are connected and properly used.** Use of dust collection can reduce dust-related hazards.
- h. **Do not let familiarity gained from frequent use of tools allow you to become complacent and ignore tool safety principles.** A careless action can cause severe injury within a fraction of a second.

#### 4) POWER TOOL USE AND CARE

- a. **Do not force the power tool. Use the correct power tool for your application.** The correct power tool will do the job better and safer at the rate for which it was designed.
- b. **Do not use the power tool if the switch does not turn it on and off.** Any power tool that cannot be controlled with the switch is dangerous and must be repaired.
- c. **Disconnect the plug from the power source and/or remove the battery pack, if detachable, from the power tool before making any adjustments, changing accessories, or storing power tools.** Such preventive safety measures reduce the risk of starting the power tool accidentally.
- d. **Store idle power tools out of the reach of children and do not allow persons unfamiliar with the power tool or these instructions to operate the power tool.** Power tools are dangerous in the hands of untrained users.
- e. **Maintain power tools and accessories. Check for misalignment or binding of moving parts, breakage of parts and any other condition that may affect the power tool's operation. If damaged, have the power tool repaired before use.** Many accidents are caused by poorly maintained power tools.
- f. **Keep cutting tools sharp and clean.** Properly maintained cutting tools with sharp cutting edges are less likely to bind and are easier to control.
- g. **Use the power tool, accessories and tool bits etc. in accordance with these instructions, taking into account the working conditions and the work to be performed.** Use of the power tool for operations different from those intended could result in a hazardous situation.
- h. **Keep handles and grasping surfaces dry, clean and free from oil and grease.** Slippery handles and grasping surfaces do not allow for safe handling and control of the tool in unexpected situations.

#### 5) SERVICE

Have your power tool serviced by a qualified repair person using only identical replacement parts. This will ensure that the safety of the power tool is maintained.

#### TERMINOLOGY USED IN THE MANUAL

- 1. **Warning:** This term means that there is a risk of physical harm or death to the operator or people nearby.
- 2. **Caution:** This term means that there is a risk of damage to the machine, cutting tool or other equipment.
- 3. **Note:** These terms offer useful information relating to the operation of the machine or its maintenance.

## Symbols used in this manual

V.....volts

A.....amperes

Hz.....hertz

W.....watt

~.....alternating current

$n_0$ .....no load speed

$\text{min}^{-1}$ .....revolutions or reciprocation

per minute

 .....warning of general danger

 .....with electrical earth



.....read these instructions



.....always wear eye protection



.....always wear a dust mask.



.....always wear hearing protection



.....wear safety-approved hard hat



do not dispose of electric tools,  
accessories and packaging together  
with household waste material

## DRILL SAFETY WARNINGS

- a. **The drill must be secured.** A drill that is not properly secured may move or tip over and may result in personal injury.
- b. **The workpiece must be clamped or secured to the workpiece support. Do not drill pieces that are too small to be clamped securely.** Holding the workpiece by hand during operation may result in personal injury.
- c. **Do not wear gloves.** Gloves may be entangled by the rotating parts or chips, leading to personal injury.
- d. **Keep your hands out of the drilling area while the tool is running.** Contact with rotating parts or chips may result in personal injury.
- e. **Make sure the accessory is rotating before feeding into the workpiece.** Otherwise the accessory may become jammed in the workpiece, causing unexpected movement of the workpiece and personal injury.
- f. **When the accessory is jammed, stop applying downward pressure and switch off the tool. Investigate and take corrective actions to eliminate the cause of the jam.** Jamming can cause unexpected movement of the workpiece and personal injury.
- g. **Avoid generating long chips by regularly interrupting downward pressure.** Sharp metal chips may cause entanglement and personal injuries.
- h. **Never remove chips from the drilling area while the tool is running. To remove chips, move the accessory away from the workpiece, switch off the tool, and wait for the accessory to stop moving. Use tools such as a brush or hook to remove chips.** Contact with rotating parts or chips may result in personal injury.
- i. **Accessories with speed ratings must be rated at least equal to the maximum speed marked on the power tool.** Accessories running faster than their rated speed can break and fly apart.

## MAGNETIC DRILL SPECIFIC SAFETY WARNINGS AND CAUTIONS

- a. **Always use safety Strap.** Mounting can release.
- b. **WARNING: While operating, only hold the crank handles, not any other part of the machine.**

Placing the hand on the machine may result in an electric shock in the event of a voltage leak or if the machine cuts its own power supply cable.

- c. **Always ensure that the work piece is a minimum of 12mm (7/16 in.) thick. If it is not, then use a piece of steel plate at least 12mm thick and larger than the magnet, below the work piece, to supplement the magnetic adhesion.** The magnet's adhesion depends on the thickness of the work piece.
- d. **Do not operate the machine on a workpiece while it is being welded.** This may lead to damage to the machine and/or personal injury.
- e. **Never position machine on a work piece between the electrode and the ground of any arc type welder.** The welder's current will ground through the earth wire in the machine's power supply cable, causing it damage.
- f. **Do not exceed 90 degrees from horizontal.** It is hazardous to use the drill upside-down.
- g. **Always ensure that the magnet is clean and free of rust and scale.** Metal chips and other debris will hamper magnetic adhesion.
- h. **Always use the tool alone on the receptacle.** Other units used on the same receptacle could cause uneven voltage that could lead to the magnet releasing.
- i. **Ensure that the magnet has properly adhered to the work piece before beginning drilling.** Proper magnet adhesion is essential for safe drilling.
- j. **When drilling non-ferrous (non-magnetic) work materials, only use a manufacturer-approved fixture such as a vacuum base adapter.** Use of accessories which are not manufacturer-approved could result in a hazardous situation.
- k. **Do not operate with dull or damaged cutting tools.** This may overload the motor.
- l. **Avoid operating annular cutters without cutting fluid.** Always check fluid level before operating. Annular cutters require cutting fluid for proper operation and long life.
- m. **Protect the motor. Never allow cutting fluid, water, or other contaminants to enter the motor.** This could lead to electric shock or motor damage.
- n. **When drilling stacked work materials, always stop to clear the slug after the first layer is drilled.** The loose slug will interfere with proper drilling.
- o. **CAUTION: Never attempt to use machine with incorrect current or abnormally low voltage.** Incorrect voltage could lead to motor damage.
- p. **This machine is not intended for production-line type use.**

## MAGNET BASE DUTY CYCLE

Do not leave the magnet base activated continuously for more than 60 minutes. If the magnet base is overheated, allow it to cool for 30 minutes before continuing.

**CAUTION: Turn the magnet base off when not in use. Leaving the magnet base on continuously will damage it.**

## ASSEMBLY

**Coolant tank assembly required.** First attach clear tube to the bottom of the coolant tank. To do this, first loosen the nut and slide nut onto the tube. Then slide tube onto the nipple. Then tighten the nut. Slide tank hanger over the screw on the upper right hand side of slide and tighten. Finally insert the other end of the tube into the quick-release connector in the gearbox. Just directly push in to install. **(To remove, first firmly**

**push the red collar of the connector and pull the tube out.)** Cutting coolant fluid is always required when using annular cutters. Open tank cover and fill. Check coolant fluid level often. Keep coolant tap closed when not in use.

**Chip guard must be used.** To attach the chip guard, use the supplied butterfly bolts to bolt to the magnet. It is not necessary to remove guard to clean chips. Simply raise guard to its upper position.

**Safety Strap must be used.** Loop strap around the workpiece, feed strap through the power tool's handle, and tighten strap using the ratchet mechanism.

## MOUNTING ANNULAR CUTTERS

**CAUTION: Never use a cutting tool that is larger than the maximum rated capacity of the machine.**

1. To insert an annular cutter, first insert the pilot pin into the cutter. Then slide the cutter into the arbor, align the proper flat with the locking screw(s) and tighten securely with the supplied hex wrench.

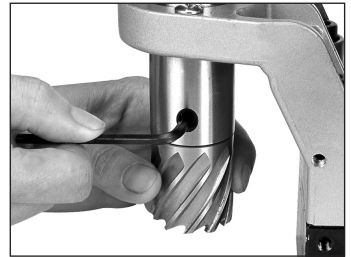

**CAUTION: Ensure that the locking screw is on a flat of the cutter and not just against the rounded shank.**

2. Ensure that the oil feed tap is on and coolant feeds properly by pushing the pilot pin. If it feeds too quickly or slowly, adjust the tap accordingly. Keep the tap closed when not in use.

## OPERATION-GENERAL

**WARNING: Always ensure that the magnet is adhered properly to the work piece before beginning drilling.**

**NOTE: If mounting to a curved surface beam, mount the machine parallel to the curve in the work piece.**

**WARNING: Avoid operating at more than 90 degrees from horizontal. When drilling at such an angle take precautions to prevent cutting coolant from entering the motor.**

**Paste-type coolant should be used.**

1. First fit tool into arbor and line up with intended center of cut. Then switch magnet on.
2. Press green motor on button to start motor. Use the crank handle to feed to work. Always use very light pressure when beginning the cut and just as the tool is breaking through. The crank handle offers tremendous leverage; so do not use too much force. Allow the cutting tool to determine the pace. With experience, the operator will be able to determine the best pace to feed to the work. There should be some degree of audible slowing of the motor but not bogging in the cut. Correct



cutting speed with a properly sharp annular cutter will produce long unbroken chips, which produce a “bird’s” nest. shaped bundle of chips around the cut.

**NOTE: Always ensure that the cutting tool is sharp. A dull cutter typically will have finer and/or choppy shavings.**

**WARNING: ALWAYS clear chips when there is too much build-up. Excessive chip build-up could result in a jammed cutter or other hazardous situation.**

**WARNING: the slug ejects at end of cut and is very hot. Always provide a method of catching the slug, where the ejected slug may cause injury to people below.**

**Note: Lock the slide lock on the side of the machine in the fully raised position when at rest to prevent the slide from accidentally slamming down - remember to unlock it again before commencing drilling.**

**CAUTION: Never attempt to cut half-circles or to stitch drill (drill overlapping holes) with a TCT cutter. This may destroy the cutter.**

**CAUTION: Never attempt to re enter a half-finished cut if the magnet has been turned off and the machine shifted in the interim. This may destroy the cutter.**

## CHANGING TOOLS & ADAPTORS WITH MT3 SHANK

To insert a tool, turn the tool until the tang lines up and firmly push into place. It is helpful to tap with a soft-faced mallet to fully engage the taper. If it is properly in position, one will not be able to pull it back apart by hand. To remove, line up the ejector slot of the arbor with the ejector port in the gear case, slide the ejector drift into the slot and tap with a hammer to eject the tool.

**CAUTION: When removing, take care that the cutting tool does not crash down and get damaged or injure anyone below.**



## MT3 ANNULAR CUTTER ADAPTOR

This machine is equipped with a unique annular cutter adaptor system with built-in coolant directly to the gearbox. No stop bar is needed.

1. To install the annular cutter adaptor, first insert the taper end of the adaptor into the arbor of the machine as described above.
2. Attach the coolant tank to the slide and ensure that the tube is attached properly.
3. To insert an annular cutter, first insert the pilot pin. Then slide the cutter into the adaptor, align the proper flat with the locking screw(s) and tighten securely with the supplied hex wrench.
4. Ensure that the oil feed tap is on and coolant feeds properly by pushing the pilot pin. If it feeds too quickly or slowly, adjust the tap accordingly. Keep the tap closed when not in use.



## OPERATION

**WARNING: NEVER operate 60mm (2-3/8 in.) or larger cutters unless the plate thickness is minimum 20mm (13/16 in.) MAGNET LIFTING MAY RESULT. If the plate thickness is not enough, supplement the magnetic adhesion by adding a 10mm or thicker plate directly under the magnet's position under the work piece.**

**CAUTION: Machine is equipped with a reversing switch. Always ensure that direction of rotation is correct before operating. Operating in the wrong direction could result in damage to the cutter.**

Select desired gear range by first popping the tab out of its detent and then sliding selectors up or down in the proper combination. Refer to the chart to achieve the correct combination for the desired speed. (It may be necessary to turn the arbor slightly in order for the gears to mesh properly). Follow the recommended speed ranges on the cutting speed chart to set the proper speed and gear range.

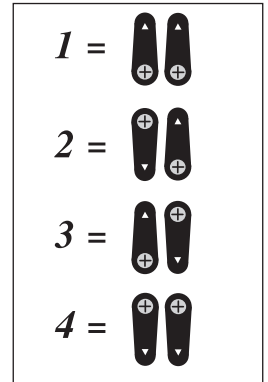

## 4 SPEED GEAR CHART

GEAR	MAX. SPEED min <sup>-1</sup>	MIN. SPEED min <sup>-1</sup>	CUTTERS	TAPS
1	120	35	Up to 120mm (4-3/4")	≤ 32 mm (1-1/4")
2	220	70	55mm-70mm (2-1/8 to 2-3/4 in.)	N/A
3	250	80	35~55mm (1-3/8 to 2-1/8 in.)	N/A
4	450	140	35mm or less (1-3/8 in.)	N/A

**NOTE: These speeds are general recommendations only. The material should determine actual speeds and the cutting speed recommended by the cutting tool manufacturer. See the section below "RECOMMENDED SURFACE SPEEDS" and use the formula to calculate the best RPM.**

**NOTE: the left and right side gear selectors have a different engagement design:**

**For The LEFT HAND SLIDER must ALWAYS ensure that the machine is FULLY STOPPED before attempting to change gears! NEVER change the Left hand slider gears on a running machine!**

**For the RIGHT HAND SLIDER the gears select by engagement dogs, similar to a motorcycle transmission design. These MUST BE SELECTED BY TURNING THE ARBOR to allow the dogs to engage.**

**CAUTION: Ensure that that gears engage fully.**

## VARIABLE MOTOR SPEED

The electronic variable motor speed control allows the motor speed to be lowered for further flexibility for adjusting the cutting speed to suit the size of cutter and type of material. Simply turn the thumb wheel to raise or lower the motor speed electronically.

**NOTE: whenever possible, it is always preferable to lower the speed by changing the gear rather than lowering the motor speed. A slower motor speed will have less cooling and somewhat less torque so always try to keep the motor going as fast as possible. Only lower the motor speed if you have no other option. (For example: If you need the RPM at about 100/min, it is much better to use 1st gear at full motor speed than to use 3rd gear at minimum motor speed.)**

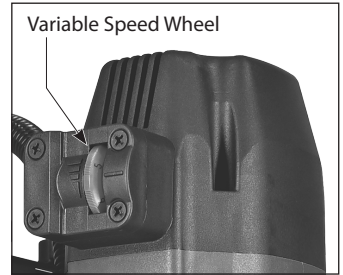

## AVOID OVERHEATING THE MOTOR

When using the machine at or near maximum capacity with a slow motor speed the motor will be at maximum stress and very hot. After each cut is finished, **ALWAYS** cool the motor by running at no load at the maximum motor speed for a few minutes.

## CUTTING SPEEDS

The type of material to be drilled, its hardness and thickness will all greatly affect the recommended cutting speed. See the chart below for general guidelines for cutting speeds. Use the formula to determine the recommended RPM for the diameter of annular cutter being used:

## RECOMMENDED SURFACE SPEEDS

**Note: work materials which have been flame cut will be heat treated in the affected area. These areas will require much slower cutting speeds.**

Work Material	Surface Speed MPM (m/min)
Aluminum	60-90
Brass	40-50
Soft Cast Iron	30-50
Hard Cast Iron	15-21
Mild Steel	24-30
High Tensile Steel	6~13
Stainless Steel	3~5

**RPM = 318.5 x MPM / cutter diameter (in mm)**

**For example:** if you are drilling mild steel with a 50mm cutter, the recommended MPM would be about 30 m/min, so the ideal RPM would be:  $318.5 \times 30/50 = 191/\text{min}$

But if you were drilling high tensile steel, the MPM would be about 6 m/min, so the ideal RPM would be:  $318.5 \times 6/50 = 38/\text{min}$

## REVERSING SWITCH

Select desired direction of rotation. This switch has 3 positions: up is forward, middle is neutral, and down is reverse rotation.

**WARNING: If the motor is switched on with the direction switch in the neutral position, the machine will not turn but will be “live”, as soon as either forward or reverse is selected, the arbor will begin turning! Take due care to avoid this situation.**



## SAFETY CLUTCH

This tool is equipped with a safety clutch which is designed to slip when the maximum torque value is exceeded. This clutch is not a tapping clutch and bottoming taps in blind hole is to be avoided.

## TWIST DRILLING

If twist drilling is desired an MT3 twist drill or an optional chuck adaptor arbor and chuck may be fitted.



## CHUCK

Mount a 16 mm (5/8") chuck to the MT3 chuck adaptor.

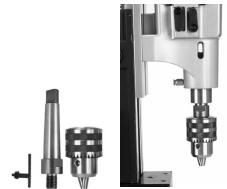

## TAPPING

**CAUTION: To avoid damage to the tap, always very carefully line the tap up with the hole and ensure that the size of the hole is correct for the tap to be used.**

**CAUTION: To avoid damage to the tap or machine, be very careful to stop the machine in time to NOT allow the tap bottom out. The motor continues to coast for a while after being shut off, so plan for this and anticipate. This machine does NOT have a tapping clutch.**

**CAUTION: To avoid damage to the machine, ALWAYS allow the machine to come to a full stop before reversing rotation.**

1. Select the proper speed according to the chart for the size of tap used.
2. Begin with forward direction of rotation with standard right hand threads. (Opposite with left-hand threads)
3. Allow the tap to determine the feed rate. A light touch on the feed handle is all that is needed once it is started in the hole.
4. When the desired thread is tapped, hit the red motor stop switch. Allow the machine to come to a full stop. Then reverse direction and restart machine by pressing the green motor switch to remove tap. Guide the tap back out with the feed handle. Proper order of operations for normal tapping is as follows:



**magnet: on. direction: forward. motor: on. motor: off. THEN: direction: reverse. motor: on. motor: off - magnet: off.**

## MAINTENANCE

Every 50 hours of operation blow compressed air through the motor while running at no load to clean out accumulated dust. (If operating in especially dusty conditions, perform this operation more often.)

1. Keep the machine clean and free of chips.
2. Check for loose fittings and tighten as needed.
3. Ensure that the ventilation slots are clear so that motor can be cooled normally. Blow low-pressure compressed air through the ventilation slots with the motor running to keep motor clean.

## THE ARBOR SHAFT

Keep the arbor shaft free of dirt and lightly grease as needed. If the arbor support bearing is noisy, it may be dirty or have a chip lodged in it. Remove the arbor shaft to clean and re-grease the arbor support bearing.

## THE GIBS (DOVETAIL SLIDES)

The gibes require adjustment if too loose. To adjust, loosen the lock nuts and adjust the adjustor screws evenly while moving the handle up and down. Adjust so that there is no free play, yet any binding anywhere in its range of travel. Then retighten the lock nuts. Periodically check, lubricate, and adjust as needed.



## THE CARBON BRUSHES

The carbon brushes are a normal wearing part and must be replaced when they reach their wear limit.

**Caution: Always replace the brushes as a pair.**

### To replace

1. Remove the 4 screws and remove the motor tail cover.
2. Using pliers rotate the brush spring out of the way and slide the old carbon brush out of the brush holder.
3. Unscrew the screw to remove the brush lead. The old carbon brush may now be lifted away.
4. Install a new brush. Installation is the reverse of removal.
5. Replace the motor tail cover.

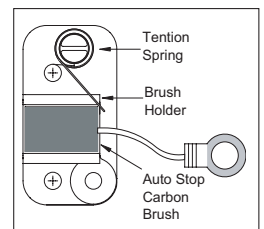

## AUTO STOP CARBON BRUSH

Due to the new auto stop carbon brush if the machine comes to a stop without any reason, the brushes have to be checked. The auto feature stops the machine

before the carbon brushes are finished and protects the motor.

## **MAGNET TROUBLESHOOTING**

Full magnet performance is absolutely essential for magnetic drill operation. If the magnet works, but does not hold well, it is likely that one of the coils has failed. If the magnet does not work at all, it is likely to be a failed rectifier. (It is highly unlikely that both magnet coils would fail at the same time)

**NOTE: A faulty magnet coil can also damage the rectifier, so whenever there is a magnet problem, BOTH the magnet coils and rectifier must be checked.**

**WARNING: Never attempt to operate a magnetic drill with a faulty magnet!**

### **CHECKING THE MAGNET (qualified technicians only)**

If the magnet is not working well, it must be checked. Separate the wires of each individual coil and test the resistance of each coil separately. (note that 110V models are wired in parallel and 230V models are wired in series) The resistance of the coils of different sizes of magnets varies, but it should be in the region of hundreds of ohms. Most importantly, both coils must have very nearly the same resistance. If one of the coils has zero resistance, it means that it is shorted. If one of the coils has infinite resistance, it means that the circuit is broken. If either coil has a problem, the magnet must be replaced. A faulty magnet may also cause damage to the rectifier. Also check the rectifier when replacing a faulty magnet. (see below)

### **CHECKING THE RECTIFIER (Qualified technicians only)**

The rectifier takes the AC household current and converts it to DC to power the magnet. If it fails, the magnet coils will not receive power.

Disconnect the rectifier and test the resistance of both circuits of the rectifier between the AC and the DC sides. Note that polarity matters, so you can only take a reading if test probes are oriented correctly. Each side will be the opposite of the other. Both circuits should have very nearly the same resistance reading. If one of the circuits has zero resistance, it means that it is shorted. If one of the circuits has infinite resistance, it means that the circuit is broken.

**If the replacement of the power supply cord is necessary, this has to be done by the manufacturer or their agent in order to avoid a safety hazard.**

**WARNING: All repairs must be entrusted to an authorized service center. Incorrectly performed repairs could lead to injury or death.**

# EXPLODED VIEW

NO.01~171 Version 2023.08.23 D.956

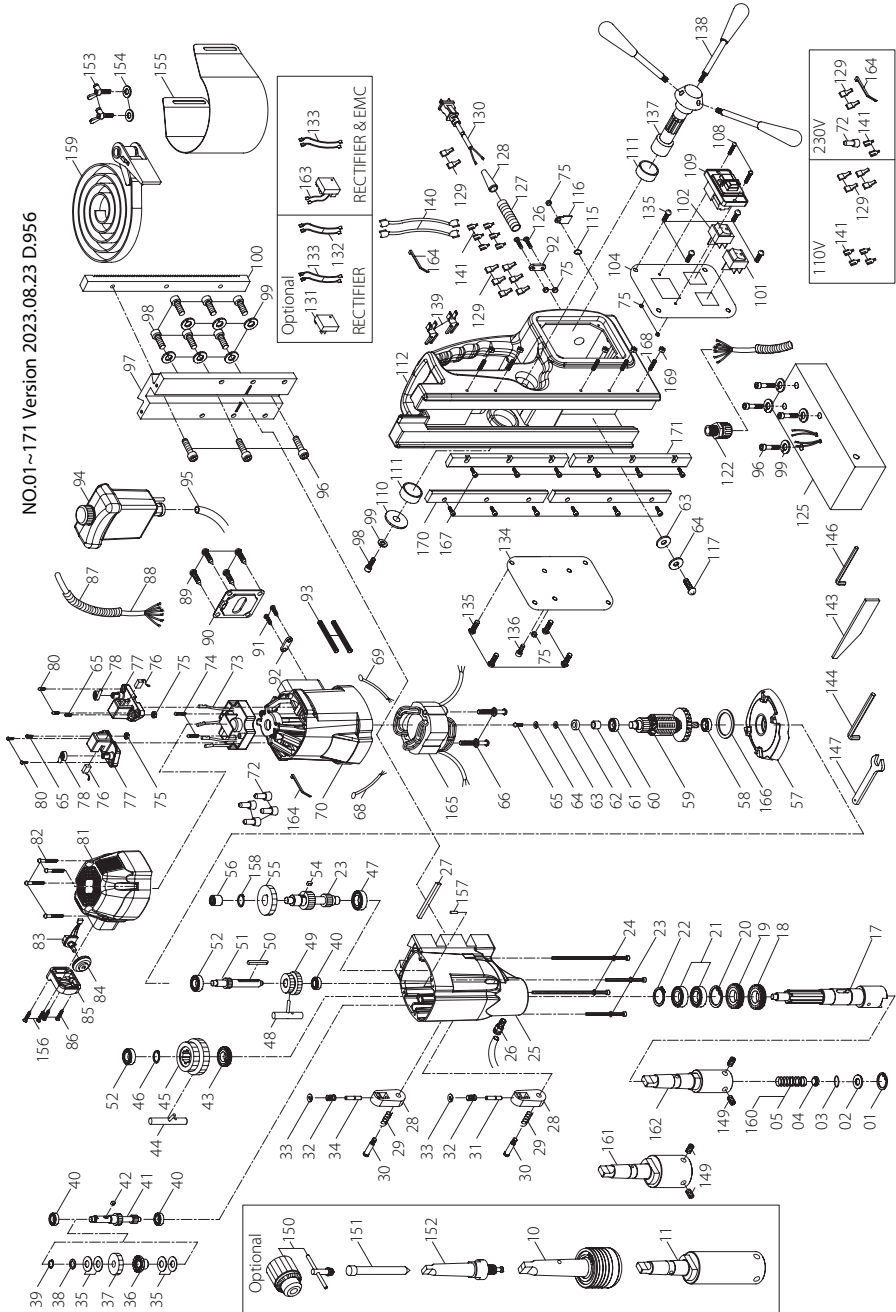

## PARTS LIST

NO.	Parts Name	Q'TY	NO.	Parts Name	Q'TY
1	INTERNAL CIRCLIP (R-19)	1	49	LAY GEAR (M1.25x27Tx32T)	1
2	FLAT WASHER (Ø10xØ18.5x0.8)	1	50	PARALLEL KEY (5x5x45)	1
3	O-RING (Ø12x4)	1	51	COUNTERSHAFT (M1.25x13T)	1
4	WATER SEAL (Ø12x15)	1	52	BALL BEARING (6200)	2
5	SPRING (Ø1.2xØ10xØ12.4x15Tx100L)	1	53	IDLER SHAFT (M1.75x17TxM2.0x9T)	1
10	MT3 CUTTER ARBOR-QUICK RELEASE, SINGLE PIN-12.3MM/11.7MM	1	54	PARALLEL KEY (5x5x8)	1
11	MT3 CUTTER ARBOR 31.7MM SHANK, 100MM DOC	1	55	IDLER GEAR (M1.25x43T)	1
17	SPINDLE	1	56	NEEDLE BEARING (HK 1212)	1
18	OIL SEAL (Ø40xØ58x8)	1	57	GEAR PLATE	1
19	OIL SEAL (Ø40xØ55x7)	1	58	BALL BEARING (6202)	1
20	INTERNAL CIRCLIP (R-55)	1	59	ARMATURE (110V/220V-94x54x45)	1
21	BALL BEARING (6006)	2	60	BALL BEARING (6200)	1
22	EXTERNAL CIRCLIP (S-30)	1	61	SPACER (Ø8xØ12x10.5)	1
23	PANHEAD TAPPING SCREW (M5x80)	2	62	PICKUP MAGNET (Ø8xØ15x5)	1
24	PANHEAD MACHINE SCREW (M5x150xP0.8)	2	63	RUBBER WASHER (Ø4xØ11x1)	2
25	GEAR HOUSING	1	64	FLAT WASHER (Ø4xØ10x1)	2
26	PUSH LOCK FITTING (PT1/8"xØ6)	1	65	PANHEAD MACHINE SCREW (M4x10xP0.7)	3
27	PARALLEL KEY (4x4x60)	1	66	PANHEAD TAPPING SCREW (M5x60)	2
28	SELECTOR TAB	2	68	WIRE LEAD (1015-16#26CM)	1
29	SPRING (Ø1xØ9xØ11x11Lx4T)	2	69	WIRE LEAD (1015-16#30CM)	1
30	SHOULDER SCREW	2	70	MOTOR HOUSING	1
31	DETENT PIN (Ø5x27)	1	72	CRIMP CAP CONNECTOR (C4)	5
32	SPRING (Ø0.6xØ5.3xØ6.5x17Lx5T)	2	73	ELECTRONICS UNIT (110V/220V)	1
33	E-CLIP (E-3)	2	74	PANHEAD TAPPING SCREW (M4x25)	2
34	DETENT PIN (Ø5x22.5)	1	75	HEX NUT (M4xP0.7)	8
35	DISC SPRING (Ø12.4xØ27.9x1)	4	76	CARBON BRUSH (7x17x17)	2
36	TOOTH CLUTCH	1	77	BRUSH HOLDER (7x17)	2
37	CLUTCH GEAR	1	78	BRUSH SPRING (0.4x4x3.5T)	2
38	THRUST WASHER (Ø12.1xØ18x1.6)	1	80	PANHEAD TAPPING SCREW (M4x12)	4
39	E-CLIP (E-10)	1	81	MOTOR TAIL CASTING	1
40	BALL BEARING (608)	3	82	PANHEAD TAPPING SCREW (M4x30)	4
41	INPUT SHAFT (M1.25x15Tx10T)	1	83	SPEED CONTROL (110V&220V)	1
42	PARALLEL KEY (5x5x10)	1	84	THUMB WHEEL	1
43	OIL SEAL (Ø28xØ38x7)	1	85	SPEED ADJUSTOR COVER	1
44	FIRST SELECTOR FORK (Ø12x64 / Ø4.8x30.8)	1	86	FLAT HEAD TAPPING SCREW (M4x16)	2
45	OUTPUT GEAR (M1.75x27TxM2.0x29T)	1	87	CABLE PROTECTOR (3/8"x65CM)	1
46	EXTERNAL CIRCLIP (S-25)	1	88	WIRE LEADS	1
47	BALL BEARING (6202)	1	89	FLAT HEAD TAPPING SCREW (M5x10)	4
48	SECOND SELECTOR FORK (Ø12x56 / Ø4.8x35.2)	1	90	MOTOR COVER PLATE	1

## PARTS LIST

NO.	Parts Name	Q'TY	NO.	Parts Name	Q'TY
91	PANHEAD TAPPING SCREW (M4x16)	2	136	PANHEAD MACHINE SCREW (M4x25xP0.7)	1
92	CABLE CLIP	2	137	CRANK SPINDLE (Ø32)	1
93	WIRE SLEEVE (Ø4x14CM)	2	138	CRANK HANDLE	3
94	COOLANT TANK ASSEMBLY	1	139	THREE WIRE PUSH IN CONNECTOR	2
95	TUBE (Ø4xØ6x40CM)	1	140	WIRE LEAD (1015-16#9CM)	2
96	SOCKET CAP SCREW (M8x20xP1.25)	7	141	FEMALE SPADE TERMINAL	10
97	SLIDE PLATE	1	143	DRIFT	1
98	SOCKET CAP SCREW-PARTIAL THREAD (M8-1.25 x 16)	7	144	HEX KEY (M5)	1
99	SPRING WASHER (M8)	11	146	HEX KEY (M2.5)	1
100	GEAR RACK	1	147	WRENCH (M8)	1
101	REVERSING SWITCH (110V&220V)	1	149	SOCKET SET SCREW (M10x10xP1.5)	4
102	MAGNET SWITCH (110V&220V)	1	150	CHUCK (5/8")	1
104	SWITCH PANEL (130.5x90.5x1.5T)	1	151	PILOT PIN (TCTx106LxØ6.34)/(TCTx108LxØ7.98)	1
108	PANHEAD MACHINE SCREW-W/WASHER (M4x20xP0.7)	2	152	CHUCK ADAPTOR (MT3-5/8")	1
109	MOTOR SWITCH (110V/220V)	1	153	BUTTERFLY SCREW (M6x10xP1.0)	2
110	FLAT WASHER (Ø8xØ40x2.5)	1	154	FLAT WASHER (Ø6xØ13x1)	2
111	BUSHING (Ø32xØ38x12)	2	155	CHIP GUARD	1
112	STAND BODY	1	156	FLAT HEAD TAPPING SCREW (M4x20)	2
115	EXTERNAL STAR WASHER (M5)	1	157	PIVOT PIN	1
116	EARTHING MARKING	1	158	EXTERNAL CIRCLIP (S-20)	1
117	PANHEAD MACHINE SCREW (M4x16xP0.7)	1	159	SAFETY BELT (BLACK)	1
122	CABLE GLAND (3/8")	1	160	SPRING (Ø1.2xØ10xØ12.4x24Tx140L)	1
125	ELECTROMAGNET (210x116x68)	1	161	ARBOR (MT3-Ø31.7)	1
126	PANHEAD MACHINE SCREW (M4x30xP0.7)	2	162	ARBOR (MT3-Ø19)	1
127	CABLE PROTECTOR (5/16"x7CM)	1	163	RECTIFIER & EMC (110V)/(110V&220V)	1
128	CORD ARMOR	1	164	ZIPTIE (2.5x100MM)	3
129	SPADE TERMINAL BOOT	12	165	STATOR (110V/220V-94x54x45)	1
130	POWER SUPPLY CABLE	1	166	O-RING (Ø35x1.5)	1
131	RECTIFIER (110&220V)	1	167	SOCKET CAP SCREW (M4-0.7 x 12)	12
132	WIRE LEAD (1015-16#18CM)	2	168	SOCKET SET SCREW (M5-0.8 x 20)	5
133	WIRE LEAD (1015-16#18CM)	2	169	HEX NUT (M5xP0.8)	5
134	SIDE PANEL (130.5x90.5x1.5T)	1	170	DOVETAIL GIB, LEFT	2
135	PANHEAD MACHINE SCREW (M4x8xP0.7)	8	171	DOVETAIL GIB, RIGHT	2



# WIRING

