

AGP[®]

Electric Airless Sprayer

PM039



Instruction Manual

CE CB



Model	1.8 kW Brushless Motor Model
Motor Type	Brushless D.C. Motor
Power Output	1.8 kW (2.4 HP)
Voltage	See machine nameplate
Max Tip Size	0.039 in.
Max Flow	6.4 l/min (1.7 gpm)
Max Pressure	227 bar (3,300 psi)
Dimensions (LxWxH)	670 x 580 x 810 mm
Weight	61 kg (134.2 lb)

Material Applications	
Wood interior:	Lacquer, Varnish, Stain, Sealer, Enamel,
Ceiling:	High-build,
Wood exterior:	Exterior Stain, Vinyl, Acrylic, Latex ,
Masonry:	Alkyd, Vinyl, Latex, Elastomeric, Block filler, Hand textures, Paint for skim coat.
Structural steel:	Heavy coating.



Suction Assy.



Adapter Head for optional Plaster Tank



9. 10.

1. Built-in Toolbox
2. Filter cap
3. Priming Valve (ball type)
4. Packing nut, Pump throat
5. T-Handle Clamp
6. Drain tube
7. Special hooks
8. Inlet Strainer
9. Fluid Pressure Control Knob
10. On / Off Switch
11. Selector button for bar or psi display
12. Suction Assy.
13. Adapter Head

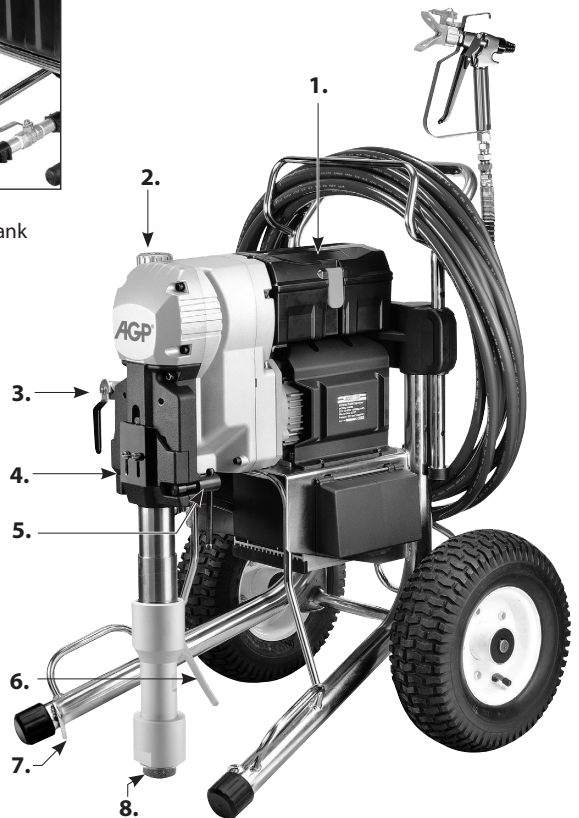

GENERAL SAFETY RULES



WARNING! Read and understand all instructions. Failure to follow all instructions listed below may result in electric shock, fire and / or serious personal injury. The term “power tool” in all of the warnings listed below refers to your mains-operated (corded) power tool.

SAVE THESE INSTRUCTIONS.

Work area

1. **Keep your work area clean and well lit.** Cluttered benches and dark areas invite accidents.
2. **Do not operate power tools in explosive atmospheres, such as in the presence of flammable liquid, gases, or dust.** Power tools create sparks which may ignite the dust or fumes.
3. **Keep bystanders, children, and visitors away while operating a power tool.** Distractions can cause you to lose control.

ELECTRICAL SAFETY

1. **Power tool plugs must match the outlet. Never modify the plug in any way. Do not use any adapter plugs with earthed (grounded) power tools.** Unmodified plugs and matching outlets will reduce the risk of electric shock. **Grounded tools must be plugged into an outlet properly installed and grounded in accordance with all codes and ordinances. Never remove the grounding prong or modify the plug in any way. Do not use any adaptor plugs. Check with a qualified electrician if you are in doubt as to whether the outlet is properly grounded.** If the tools should electrically malfunction or break down, grounding provides a low resistance path to carry electricity away from the user.
2. **Avoid body contact with grounded surfaces such as pipes, radiators, ranges**

and refrigerators. There is an increased risk of electric shock if your body is earthed or grounded.

3. **Do not expose power tools to rain or wet conditions.** Water entering a power tool will increase the risk of electric shock.
4. **Do not abuse the cord. Never use the cord for carrying, pulling or unplugging the power tool. Keep the cord away from heat, oil, sharp edges or moving parts. Replace damaged cords immediately.** Damaged or entangled cords increase the risk of electric shock.
5. **When operating a power tool outdoors, use an outdoor extension cord suitable for outdoor use.** Use of a cord suitable for outdoor use reduces the risk of electric shock.

PERSONAL SAFETY

1. **Stay alert, watch what you are doing and use common sense when operating a power tool. Do not use tool while you are tired or under the influence of drugs, alcohol, or medication.** A moment of inattention while operating power tools may result in serious personal injury.
2. **Use safety equipment. Always wear eye protection.** Safety equipment such as dust mask, non-skid safety shoes, hard hat, or hearing protection used for appropriate conditions will reduce personal injuries.
3. **Avoid accidental starting. Ensure the switch is in the off position before plugging in.** Carrying tools with your finger on the switch or plugging in tools that have the switch on invites accidents.
4. **Remove adjusting key or wrench before turning the power tool on.** A wrench or a key left attached to a rotating part of the tool may result in personal injury.
5. **Do not overreach. Keep a proper footing and balance at all times.** This enables better control of the power tool in unexpected situations.
6. **Dress properly. Do not wear loose clothing or jewellery. Keep your hair, clothing and**

gloves away from moving parts. Loose clothes, jewellery or long hair can be caught in moving parts.

- If devices are provided for the connection of dust extraction and collection facilities, ensure these are connected and properly used.** Use of these devices can reduce dust-related hazards.

POWER TOOL USE AND CARE

- Do not force the power tool. Use the correct power tool for your application.** The correct power tool will do the job better and safer at the rate for which it was designed.
- Do not use the power tool if the switch does not turn it on and off.** Any power tool that cannot be controlled with the switch is dangerous and must be repaired.
- Disconnect the plug from the power source before making any adjustments, changing accessories, or storing power tools.** Such preventive safety measures reduce the risk of starting the power tool accidentally.
- Store idle tools out of reach of children and do not allow persons unfamiliar with the power tool or these instructions to operate the power tool.** Power tools are dangerous in the hands of untrained users.
- Maintain power tools. Check for misalignment or binding of moving parts, breakage of parts and any other condition that may affect the power tool's operation. If damaged, have the power tool repaired before use.** Many accidents are caused by poorly maintained power tools.
- Keep cutting tools sharp and clean.** Properly maintained cutting tools with sharp cutting edges are less likely to bind and are easier to control.
- Use the power tool, accessories and tool bits etc., in accordance with these instructions and in the manner intended for the particular type of power tool, taking into account the working conditions and the work to be performed.** Use of the power tool for operations different from intended

could result in a hazardous situation.

SERVICE

Have your power tool serviced by a qualified repair person using only identical replacement parts. This will ensure that the safety of the power tool is maintained.

If the supply cord of this power tool is damaged it must be replaced by a specially prepared cord available through the service organization.

Symbols used in this manual

V.....volts
 A.....amperes
 Hz.....hertz
 W.....watt
 ~.....alternating current
 n_0no load speed
 min⁻¹.....revolutions or reciprocation
 per minute

warning of general danger

with electrical earth



read these instructions

always wear eye protection

always wear a dust mask.

always wear hearing protection

wear safety-approved hard hat

 do not dispose of electric tools, accessories and packaging together
 with household waste material

Specific safety rules for Airless Sprayers

HANDLE THIS UNIT AS YOU WOULD A LOADED WEAPON!

Extreme high pressure spray can cause extremely serious injury.

OBSERVE ALL WARNINGS!

SPECIFIC SAFETY RULES

WARNING: Do not use guns for spraying flammable materials.

WARNING: Be aware of any hazards presented by the material being sprayed, and consult the markings on the material container or the information supplied by the manufacturer of the material to be sprayed.

WARNING: Do not spray any material where the hazard is not known.

WARNING: Do not clean guns with flammable solvents with a flash-point below 55°C.

NOTE: A non-flammable solvent is here defined as one which has a flash-point above 55°C.

WARNING: This appliance cannot be used by children under 18 years old or persons with reduced physical, sensory or mental capabilities or lack of experience or knowledge of the safe operation of the appliance.

WARNING: Children may not play with this appliance.

WARNING: Cleaning and user maintenance shall not be made by children.

WARNING: This appliance shall be disconnected from its power source during service and when replacing parts. The plug must remain removed, and must be removed in such a way that an

operator can check from any of the points to which he has access that the plug remains removed.

WARNING: HIGH PRESSURE. Never leave pressurized system unattended. Always follow the Pressure Relief Procedure. Take precautions to avoid high pressure component rupture.

DANGER: INJECTION INJURY. Skin injection by high pressure paint is not a simple cut. It must be treated surgically immediately.

WARNING: FIRE AND EXPLOSION HAZARD. Take all precautions to avoid sources of sparks and ignition when spraying. Keep the machine at least 8 meters away from the spraying operation.

WEAR PROTECTIVE EQUIPMENT AT ALL TIMES. Always use a respirator, eye protection and protective clothing.

Keep clear of moving parts when starting or operating the sprayer. Do not put your fingers into any openings to avoid amputation by moving parts or burns on hot parts. When starting the motor, maintain a safe distance from moving parts of the equipment.

Before adjusting or servicing any mechanical part of the sprayer, follow the PRESSURE RELIEF PROCEDURE.

EXPLOSION RISK FROM HALOGENATED HYDROCARBON SOLVENTS

Never use halogenated hydrocarbon solvents in this machine.

Contact with aluminum parts may cause an explosion.

Some of the most common of these solvents are: Carbontetrachloride, Chlorobenzene, Dichloroethane, Dichloroethyl Ether, Ethylbromide, Ethylchloride, & Tetrachloethane.

PREVENT STATIC SPARKING FIRE/ EXPLOSIONS

Vapors created when spraying can be ignited by sparks.

To reduce the risk of fire, always locate the sprayer at least 20 feet (6 m.) away from spray area. Do not plug in or unplug any electrical cords in the spray area. Doing so can cause sparks which can ignite any vapors still in the air. Follow the coating & solvent manufacturers safety warnings and precautions.

MEDICAL ALERT - Airless Spray Injection Injuries

If any fluid appears to penetrate your skin,

GET EMERGENCY MEDICAL CARE AT ONCE. DO NOT TREAT AS AN ORDINARY CUT.

High pressure fluids from spray or leaks are powerful enough to easily penetrate the skin and cause extremely serious injection injury, leading to the possible need for amputation.

- **NEVER** point the spray gun at anyone or any part of the body.
- **NEVER** put your hand or fingers over the spray tip. Do not use a rag or any other materials over your fingers. Paint will penetrate through these materials & into the hand.
- **NEVER** try to stop or deflect leaks with your hand or body.
- **ALWAYS** have the tip guard in place when spraying.
- **ALWAYS** lock the gun trigger when you stop spraying.
- **ALWAYS** remove tip from the gun to clean it.
- **NEVER** try to "blow back" paint, this is not an air powered sprayer.
- **ALWAYS** follow the **PRESSURE RELIEF PROCEDURE** before cleaning or removing the spray tip or servicing any system equipment.
- Be sure the equipment safety devices are operating properly before each use.

- Tighten all of the fluid connections before each use.
- **NEVER** alter equipment in any manner.
- **NEVER** smoke while in spraying area.
- **NEVER** spray highly flammable materials.
- **NEVER** use around children.
- **NEVER** allow another person to use sprayer unless he is thoroughly instructed on its safe use and given this operator's manual to read.
- **ALWAYS** wear a spray mask, gloves and protective eye wear while spraying.
- **ALWAYS** ensure fire extinguishing equipment is readily available and properly maintained.

NEVER LEAVE SPRAYER UNATTENDED WITH PRESSURE IN THE SYSTEM. FOLLOW PRESSURE RELIEF PROCEDURES

ALWAYS INSPECT SPRAYING AREA

- Keep the spraying area free from obstructions.
- Make sure the spraying area has good ventilation to safely remove vapors and mists.
- **NEVER** keep flammable material in spraying area.
- **NEVER** spray in vicinity of open flame or other sources of ignition.
- The spraying area must be at least 20 ft. away from spray unit.

SPRAY GUN SAFETY

- **ALWAYS** set gun safety lock in the "LOCKED" position when not in use & before servicing or cleaning.
- **NEVER** remove or modify any part of the gun.
- **ALWAYS REMOVE THE SPRAY TIP** when cleaning. Flush unit at the **LOWEST POSSIBLE PRESSURE**.
- **ALWAYS** check operation of all gun safety devices before each use.
- Be very careful when removing the spray tip or hose from the gun. A plugged line will contain fluid under pressure. If the tip or line is plugged, follow the pressure relief procedure

TIP GUARD

- **ALWAYS** have the tip guard in place on the spray gun while spraying. The tip guard alerts you to the injection hazard and helps prevent accidentally placing your fingers or any part of your body close to the spray tip.

SPRAY TIP SAFETY

- Use extreme caution when cleaning or changing spray tips. If the spray tip clogs while spraying, engage the gun safety latch immediately. **ALWAYS** follow the **PRESSURE RELIEF PROCEDURE** and then remove the spray tip to clean it.
- **NEVER** wipe off build up around the spray tip.

TOXIC FLUID HAZARD

- **ALWAYS** remove tip guard & tip to clean AFTER pump is turned off and the pressure is relieved by following the **PRESSURE RELIEF PROCEDURE**.
- Hazardous fluid or toxic fumes can cause serious injury or death if splashed in eyes or on skin, inhaled or swallowed. Know the hazards of the fluid you are using. Store & dispose of hazardous fluid according to manufacturer, local, state & national guidelines.
- **ALWAYS** wear protective eyewear, gloves, clothing and respirator as recommended by fluid manufacturer.

HOSES

- Tighten all of the fluid connections securely before each use. High pressure fluid can dislodge a loose coupling or allow high pressure spray to be emitted from the coupling and result in an injection injury or serious bodily injury.
- Only use hoses with a spring guard. The spring guard helps protect the hose from kinks or

other damage which could result in hose rupture and cause an injection injury. Do not allow kinking or crushing of hoses or allow it to vibrate against rough, sharp or hot surfaces.

- Use only conductive fluid hoses for airless applications. Be sure the gun is grounded through the hose connections. Use only high pressure airless hoses with static wire which are approved for 3000 psi.
- **NEVER** use a damaged hose, which can result in hose failure or rupture and cause an injection injury or other serious bodily injury or property damage. Before each use, check entire hose for cuts, leaks, abrasions, bulging of the cover, or damage or movement of couplings. If any of these conditions exist, replace the hose immediately.
- **NEVER** use tape or any device to try to mend the hose as it cannot contain the high pressure fluid. **NEVER ATTEMPT TO RECOUPLE THE HOSE.** A high pressure hose is not possible to recouple.

GROUNDING

- Ground the sprayer & other components in the system to reduce the risk of static sparking, fire or explosion which can result in serious bodily injury and property damage. For detailed instructions on how to ground, check your local electrical code.
- **ALWAYS** ensure switch is in OFF position before plugging unit in.

ALWAYS GROUND ALL OF THESE COMPONENTS:

1. **Sprayer:** plug the power supply cord, or extension cord, each equipped with an undamaged three-prong plug, into a properly grounded outlet. **DO NOT USE AN ADAPTER.** Use only a 3 wire extension cord that has a grounding plug, and a receptacle that will accept the grounding plug on the product. Make sure your extension cord is in good condition. When using an extension cord, be

sure to use one heavy enough to carry the current your product will draw. If in doubt, use the next heavier gauge.

2. **Fluid hose:** use only grounded hoses.
3. **Spray gun or dispensing valve:** grounding is obtained through connection to a properly grounded fluid hose and pump.
4. **All solvent pails must be conductive metal material and properly grounded. Do not place on a non conductive insulating surface unless a ground wire is added to a true earth such as a metal water pipe.**

ALWAYS ensure fire extinguishing equipment is readily available and properly maintained.

FLUSHING SAFETY

WHEN SPRAYING & CLEANING WITH FLAMMABLE PAINTS AND THINNERS

1. When spraying with flammable liquids, the unit must be located a minimum of 25 feet away from the spraying area in a well ventilated area. Ventilation must be sufficient enough to prevent the accumulation of vapors.
2. To eliminate electrostatic discharge, ground the spray unit, paint bucket & spraying object. See **GROUNDING**. Use only high pressure airless hoses approved for 3000 psi which is conductive.
3. Remove the spray tip before flushing. Hold the metal part of the gun firmly to the side of a metal pail & use the lowest possible fluid pressure during flushing.
4. Never use high pressure in the cleaning process. **USE MINIMUM PRESSURE.**
5. Do not smoke in spraying/cleaning area.

NEVER use cleaning solvents with flash points below 140 degrees F. Some of these are: acetone, benzene, ether, gasoline, naptha. Consult your supplier to be sure.

ASSEMBLY

Tools needed: Two adjustable wrenches-not

included.

1. Attach the hose to the pump and tighten with a wrench.



2. Attach the hose to the gun and tighten with two wrenches.

PLASTER TANK (optional)

The optional plaster tank allows the plaster to be fed directly into the machine.

The plaster tank requires using the plaster tank adapter head in place of the standard suction assembly to allow it to couple with the tank. If the standard suction head is mounted, it must be removed and the internal parts must be transferred over to the plaster tank adaptor head. Unscrew the check ball housing (1) from the suction housing (8) and remove the ball guide (6), spacer (7), spring (5) and check ball (4). Then press out the intake disc (3) from the check ball housing (1). Insert the parts into the plaster tank adaptor head and mount it on the machine.

Engage the front legs of the sprayer's frame with the corresponding brackets on the plaster tank's frame. Then thread on the coupling of the plaster tank to the plaster tank adaptor head and tighten. Keep the valve on the bottom of the plaster tank closed when not in use or when uncoupling the sprayer from the tank.

CAUTION: When spraying plaster or other highly viscous materials, with or without the plaster tank, the inlet strainer should be removed. The strainer will restrict suction which could cause suction cavitation, leading to pump damage.

ELECTRICAL CONNECTION

The network voltage must conform to the voltage indicated on the tool name plate. Under no circumstances should the tool be used when the power supply cable is damaged. A damaged cable must be replaced immediately by an authorized Customer Service Center. Do not try to repair the damaged cable yourself. The use of damaged power cables can lead to an electric shock.

GROUNDING INSTRUCTIONS

This product must be grounded. In the event of an electrical short circuit, grounding reduces the risk of electric shock by providing an escape wire for the electric current. This product is equipped with a cord having a grounding wire with an appropriate grounding plug. The plug must be plugged into an outlet that is properly installed and grounded in accordance with all local codes and ordinances.

WARNING - Improper installation of the grounding plug can result in a risk of electric shock.

If repair or replacement of the cord or plug is necessary, do not connect the green grounding wire to either flat blade terminal. The wire with insulation having a green outer surface with or without yellow stripes is the grounding wire and must be connected to the grounding pin. Check with a qualified electrician or serviceman if the grounding instructions are not completely understood, or if you are in doubt as to whether the product is properly grounded. Do not modify the plug provided. If the plug will not fit the outlet, have the proper outlet installed by a qualified electrician.

IMPORTANT: use only a 3-wire extension cord that has a 3-blade grounding plug and a 3-slot receptacle that will accept the plug on the product. Make sure your extension cord is in good condition. When using an extension cord, be sure to use one

heavy enough to carry the current your product will draw. an undersized cord will cause a drop in line voltage resulting in loss of power and overheating. a 12 gauge cord is recommended. If an extension cord is to be used outdoors, it must be marked with the suffix W-A after the cord type designation. For example, a designation of SJTW-A would indicate that the cord would be appropriate for outdoor use.

OPERATION

Before beginning always check and tighten all fittings securely.

WARNING: A loose connection could burst loose under pressure causing a hazardous condition. Ensure that all connections are tight. This includes both ends of the hose, the gun filter, the tip guard, the pump filter, and the suction tube gland nut.

WARNING: Always ensure that the gun safety latch is in the locked position.

The gun safety latch should always be set. The only time the trigger should be unlocked is when the gun is actually being triggered.

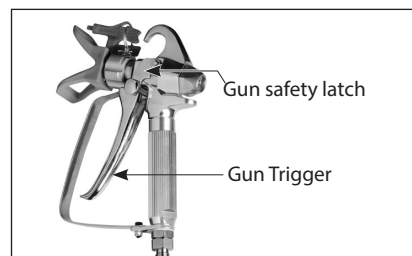

Leave the tip out of the gun when priming, flushing and cleaning.

LUBRICATE THE PACKINGS

Fill the packing nut/wet cup with about 2-3 drops of throat seal oil.



PREPARE AT LEAST THREE BUCKETS

The first bucket will hold the material to be sprayed. The second bucket will hold flushing fluid, which will be either mineral spirits (for oil-based materials), lacquer thinner (for lacquers), water (for water based materials), or soapy water (for converting from oil-based or lacquer to water-based materials). The third bucket will be the waste bucket.

FLUSHING

When to flush the pump

1. When the pump is filled with storage fluid, as when you are operating your new airless sprayer for the first time, or taking out of storage. Flush with mineral spirits. (If you plan to use water-based material see part 2 below.)
2. When changing between oil-based and water-based materials. First flush with mineral spirits, followed by a soapy water flush, followed by a clear water flush.
3. When changing between water-based and oil-based materials. First flush with clear water, then flush with mineral spirits.
4. When changing colors. Flush with a compatible solvent, such as water or mineral spirits as needed.
5. When cleaning up. See the section on **CLEANUP** later in this manual.
6. Storage. Leave the pump filled with a 50/50 mixture of mineral spirits and motor oil.

CAUTION: Never leave water in the pump for more than about a day. Flush with mineral spirits.

HOW TO FLUSH

1. Place the suction tube/suction hose in a flushing bucket filled with clean flushing fluid: either mineral spirits (for oil-based materials), lacquer thinner (for lacquers), water (for water-based materials), or soapy water (for converting from oil-based to water-based materials).
2. Separate the drain tube from the suction tube (if they are clipped together) and place it in an empty waste bucket.
3. Open the priming valve.
4. Ensure that the unit is turned off and the pressure control knob is at the minimum (anticlockwise) setting. Plug the unit in.
5. Turn the unit on.
6. Turn the pressure control knob clockwise to increase the pressure just enough to let the pump run.
7. Allow the pump to run and watch the fluid discharging from the drain tube. Allow the fluid to discharge until completely clean flushing fluid is coming out. The hose and gun also need to be flushed when changing colors or when switching between different types of materials/paints:
(If the hose and gun do not need flushing, proceed to step 11.)
8. With the tip and tip guard removed from the gun, point the gun into the waste bucket and hold the trigger open.
WARNING: Risk of static sparking, fire or explosion. Hold the metal part of the gun firmly to the side of a metal pail. All solvent pails must be conductive metal material and properly grounded. Do not place on a non conductive insulating surface unless a ground wire is added to a true earth such as a metal water pipe.
9. Close the priming valve.
10. Allow the pump to run and watch the fluid

discharging from the gun. Allow the fluid to discharge until completely clean flushing fluid is coming out.

WARNING: Do not release the gun trigger during this process. If you release the trigger, pressure will build in the line and when you re-squeeze the trigger there will be a splashback hazard.

11. Then turn the unit off and turn the pressure control knob anticlockwise back to the minimum setting. Then unplug the unit. The pump is now clean and ready to be primed with material.

PRIMING

This is a high pressure pump and all air and unwanted fluids must be bled out of the pump and lines before spraying can begin.

Ensure that the tip and tip guard are removed from the gun and the trigger is locked.

TO PRIME

1. Place the suction tube in the material bucket.
2. Place the drain tube in a waste bucket and open the priming valve.
3. Ensure that the pressure control knob is in the minimum position and the unit is switched off. Plug the unit in and turn it on.
4. Slowly turn the pressure control knob clockwise to increase the pressure just enough to let the pump run.
5. Allow the pump to run and watch the fluid discharging from the drain tube. Allow the fluid to discharge until pure material is coming out.
6. Point the gun into the waste bucket, unlock the trigger and hold the trigger open. Then close the priming valve.
7. Keep the trigger held open and allow the pump to run and watch the fluid discharging from the gun. Allow the fluid to discharge until

pure material is coming out. Turn the machine off.

8. To further bleed out any air, point the gun into the material bucket or hopper and hold the trigger open. Turn the machine on and allow clean material to recirculate. Watch the material to make sure there are no air bubbles.
9. Now turn off the unit and lock the trigger. The drain tube may now be rejoined to the suction tube in the material bucket.

The unit is now primed and ready to install the tip and tip guard.

SPRAY TIP ASSEMBLY (reversible type tips)

WARNING: If the unit is pressurized, follow the PRESSURE RELIEF PROCEDURE before performing any adjustment with the tip.

Please see the section below “**Spray Tip Selection**” to choose the right tip for your application.

1. Double check to be sure the gun safety latch is locked before assembling tip and tip guard to the gun.

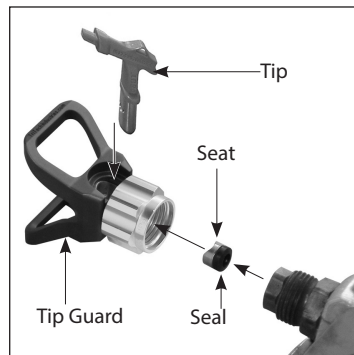

2. If it is not installed, ensure the seal is snapped in place on the seat and insert the seat into the tip guard. Make sure that it is aligned to the circular opening in the tip guard.
3. Thread the tip guard onto the gun finger tight only.
4. Insert the tip into the tip guard and ensure

that it is fully home. Rotate the tip all the way to the forward position. (the arrow on the tip handle will point forward). The tip can be rotated 180 degrees for clearing clogs.

5. Turn the tip guard assembly to the desired orientation and tighten the lock nut firmly by hand only.

WARNING: Never attempt to spray with the tip in any position in-between either fully forward or fully reversed. It could cause a high pressure hazard.

You are now ready to spray.

PRESSURE RELIEF PROCEDURE.

Whenever you stop spraying, even for a short break, follow the "Pressure Relief Procedure".

IMPORTANT! To avoid possible serious body injury, always follow this procedure whenever the sprayer is shut off, when checking it, when installing, changing or cleaning tips, when adding material and whenever you stop spraying for any reason. Never leave the unit unattended while in a pressurized condition.

1. Engage the gun safety latch.
2. Turn the unit off.
3. Disengage the gun safety latch and trigger the gun to relieve residual fluid pressure. Hold metal part of the gun in contact with a grounded metal bucket. Re-engage safety latch.

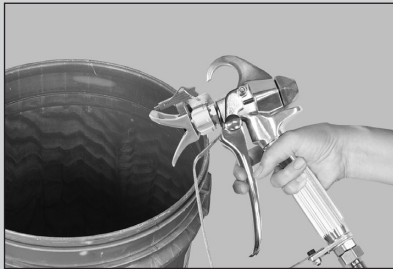

4. Slowly turn the Priming Valve to the open (priming) position to relieve any residual fluid pressure. Then close priming valve.

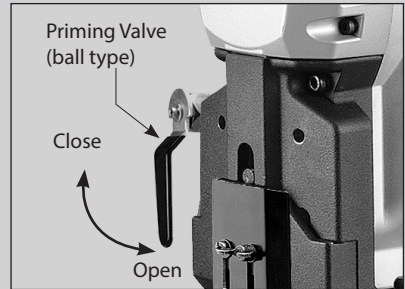

WARNING: If the SPRAY TIP OR HOSE IS CLOGGED, Expect material splashing into the bucket while opening the Priming Valve. So open the valve very slowly and take precautions.

SPRAYING -ALL MODELS

Check the quality of the spray pattern on a piece of scrap material, such as cardboard. Turn the Pressure Control Knob Clockwise to increase pressure and counterclockwise to decrease pressure.

Start with a low spray pressure and slowly increase the pressure until a good spray pattern is achieved. If the pressure is too low, the pattern will have "tails", which is a pattern with heavy, uneven edges. Keep testing and increasing pressure until a smooth, regular pattern is achieved. If the pressure is at maximum and the pattern is still not ideal, either go to a smaller orifice tip or thin the material. Do not raise the pressure any higher than is necessary. Operating the sprayer at a higher than necessary pressure wastes material, causes early tip wear, and shortens sprayer life. Excessive pressure can also result in bounce-back of the material and a rough finish. (Running with the pressure at the absolute maximum setting will also make the pump run on and off in an irregular way.)

NOTE: Use proper pressure settings. Do not rely on the readout to set the pressure. The only way to set the pressure is to test spray on scrap materials and observe the spray pattern.

While spraying, consistently hold the gun perpendicular, about 25-30cm (10-12 inches) away from the surface. Do not swing the gun. Do not tilt the gun.

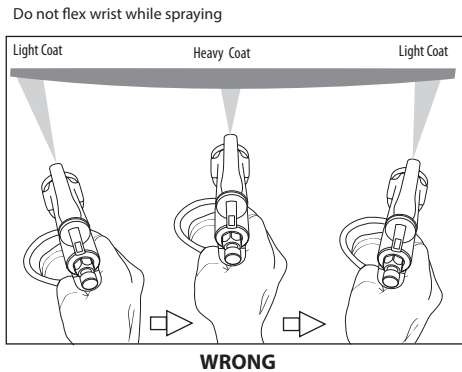
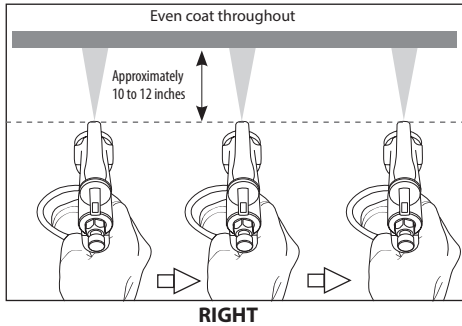

Trigger the gun before moving and release the trigger after each stroke. Overlap each previous stroke by half. Do this by aiming the tip to the edge of the previous stroke.

Work in sections within your reach. When painting corners, point the gun parallel to the corner. Cut in edges and corners first. Then paint flat areas.

Do not allow the material to run out. **Remember to follow the PRESSURE RELIEF PROCEDURE before refilling material.** If the material does run out, the pump will suck in air. This air must be bled

out before continuing. Follow the instructions for "Priming" above.

TO REMOVE CLOGS FROM SPRAY TIP (reversible tips)

1. Lock gun safety latch and follow the **PRESSURE RELIEF PROCEDURE.**
2. Turn Tip handle 180 degrees.
3. Disengage trigger lock & trigger gun into pail.
4. If the Tip handle appears locked loosen the retaining nut. The handle will now turn easily.
5. Engage gun safety latch & return tip to the spray position.

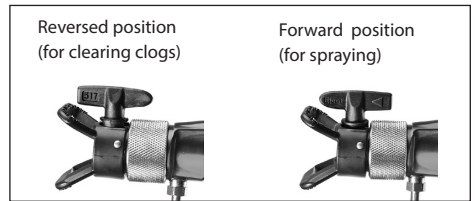

CLOGGED FLAT TIP

If you are using a flat tip and the spray tip becomes clogged, relieve pressure from hose by following the "**PRESSURE RELIEF PROCEDURE.**" Secure gun with the safety latch, take off guard, take out the tip, soak in appropriate solvent & clean with a soft brush. (Do not use a needle or sharp pointed instrument to clean the tip. The tungsten carbide is brittle and can chip.)

SPRAY TIP SELECTION (See chart 1)

Spray tip selection is based on paint viscosity, paint type, and job needs. There are two variables to identify the tip: orifice size and fan pattern width.

The main variable is tip orifice size. Generally, use a smaller orifice tip For light viscosities (thin materials, like varnish), and use a larger orifice tip for heavier viscosities (thicker materials, like latex paints).

Spray tip orifice size is based on how many gallons of paint per minute can be sprayed through the tip.

Do not use a tip larger than the maximum pump flow rate or capacity the sprayer can accommodate.

Pump flow rate is measured in gallons per minute (GPM) and liters per minute (LPM).

The other variable is the fan pattern width. Two tips having the same orifice tip size, but different fan widths will deliver the same amount of paint over a different area (wider or narrower strip). A spray tip with a narrow fan width makes it easy to spray in tight places. (Thickness of the material coat per stroke is determined by spray tip fan width, rate of the spray gun movement, and distance to surface.) The numbers on the tip identify its orifice size and fan width. The first number on the tip identifies the fan width radius in inches. The last two numbers identify the orifice size in thousandths of an inch. So, for example, a 517 tip would have a 10 inch fan width (5 inch radius) and a 0.017 inch orifice size.

A General Guide for Tip Sizes, Flow Rates and Pressures at the Gun (chart 1)

Material	Atomization Pressure (at the gun)	Min. Required Flow Rate	Tip Size	Recommended Hose
Lacquer & semi-transparent stains	1300 PSI (90 BAR)	0.4 gpm (1.5L/min)	0.011" - 0.017"	1/4"
Oil/alkyd enamels & primers	1500 - 2000 PSI (100 - 140 BAR)	0.4 - 1.0 gpm (1.5 - 3.8L/min)	0.013" - 0.017"	
Solid color stains			0.015" - 0.017"	
Interior & exterior latex paints & primers			0.015" - 0.025"	
Smooth elastomeric coatings	2000 - 2500 PSI (140 - 170 BAR)	1.0 gpm (3.8L/min)	0.023" - 0.027"	3/8"
Latex block fillers			0.025" - 0.030"	
Elastomeric coatings			0.025" - 0.035"	

The atomization pressure is the pressure at the gun, this will always be lower than the pressure at the pump because the viscosity of the paint, the gun, as well as the length and diameter of the hose will all cause a pressure drop.

There are many many variables which will effect the spraying pressure such as the temperature and humidity, the hose, the paint, etc. So, after choosing the right sized tip, the operator must always fine-tune the pressure to suit the unique conditions of his situation.

SPRAY TIP REPLACEMENT

During use, especially with latex paint, grit and impurities in the paint under high pressure will cause the orifice to grow larger from wear and for the fan pattern width to degrade.

It is easy to determine the state of wear of the tip by observing the fan pattern. As the tip wears, the fan width will become narrower. A new tip will have a pattern shaped like a narrow long rounded-corner rectangle. As it wears it will turn into an oval shape. When it is completely worn out it sprays a circle. When the fan width decreases to about 2/3 of its original size, it is considered worn out.

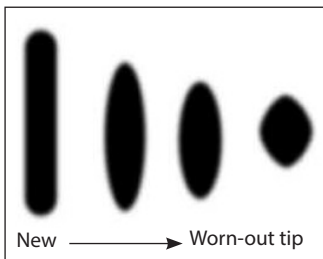

Note: To minimize wear to the tip, piston, packings and seats, it is best to always strain paint before use with a paint strainer bag and regularly clean all filters and strainers.

Replace tips before they become excessively worn. Worn tips waste paint, cause overspray, make cutting-in difficult, and decrease sprayer performance.

If the tip is the maximum rated size for your sprayer, when it wears, it will exceed the flow rate capacity of the machine. If when using the maximum capacity tip size the pump cannot keep up, then you know that the tip is worn beyond capacity.

CLEANUP

At the end of the day, the material in the line should be recovered and the machine thoroughly cleaned. This will avoid material drying in the pump or hose.

CAUTION: Under no circumstances allow material to dry in the pump. If material dries in the pump and hose, the pump will need to be completely disassembled and rebuilt and the hose will need to be discarded and replaced.

1. Relieve pressure in the system according to **the Pressure Relief Procedure.**
2. Remove the tip and tip guard and soak in the appropriate solvent for the material being used.
3. Rinse off the suction tube and place in a bucket of the appropriate flushing solvent fluid. Usually this will be water (for water-based materials), mineral spirits (for oil-based materials) or lacquer thinner (for lacquers). Special flushing fluids may be required for component materials or epoxies, etc.
4. To reclaim the material in the pump, place the drain tube in the original material bucket. With the priming valve still in the open position, turn the machine on and turn the pressure control knob clockwise just enough to run the pump. watch the material discharging from the drain tube until the material begins to thin. This indicates that the flushing fluid is beginning to pump out. Now transfer the drain tube to the waste bucket and continue to flush until clear flushing fluid flows out.
5. Shut off the machine and back off the pressure control knob to minimum. Close the priming valve.
6. To reclaim the material in the line, with the tip and guard removed, point the gun into the material bucket and hold the trigger open.
7. Place the waste bucket right next to the material bucket.
8. Ensure that the pressure knob is in the minimum position and turn the unit on.
9. With the trigger held open, slowly turn the pressure knob clockwise to increase the pressure just enough to let the pump run.
10. Allow the pump to run and watch the material discharging from the gun. Allow the material to discharge until the material begins to thin. This indicates that the flushing fluid is coming up the hose..

11. Without releasing the trigger, quickly transfer the gun from the material bucket to the waste bucket next to it.

WARNING: Do not release the gun trigger during this process. If you release the trigger, pressure will build in the line and when you re-squeeze the trigger there will be a splashback hazard.

12. Keep the trigger held open and allow the pump to run and watch the fluid discharging from the gun. Allow the fluid to discharge until all traces of material are gone and pure flushing fluid is coming out.
13. Without releasing the trigger, transfer the gun to the flushing bucket and allow the flushing fluid to recirculate for 2-3 minutes to make sure that all traces of the material are cleaned out.
14. Turn off the machine and unplug. Open the priming valve to relieve residual pressure.
15. Remove the suction tube out of the flushing fluid.
16. Clean the inlet strainer or hopper strainer. Remove and clean it with a soft brush in the appropriate solvent and replace.
17. Clean the pump filter. Using the supplied wrench, remove the pump filter and clean it with a soft brush in the appropriate solvent. Then replace and tighten.
18. **Clean the gun, tip, and gun filter.** unclip the hand guard and rotate it out of the way. Then, using a wrench (not supplied) loosen the nut on the bottom of the handle and remove the handle to remove the gun filter. Clean the tip and filter with a soft brush in the appropriate solvent. Apply a small amount of light oil such as WD-40 to the inside of the spray gun housing. Place the filter in the spray gun and reassemble the unit by tightening the nut with the wrench.
19. Clean the exterior of the sprayer with a rag soaked in the appropriate solvent.
20. If flushing was with water, flush again with mineral spirits to prevent corrosion inside the pump.

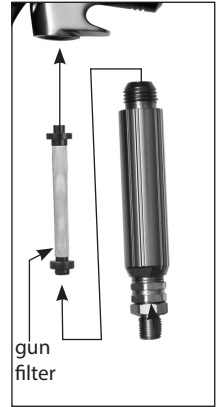
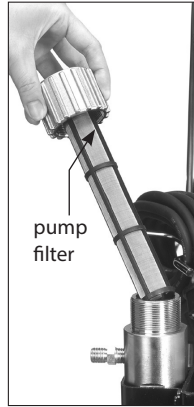

CAUTION: Never leave water in the pump for any length of time. Water will corrode the pump.

LONG TERM STORAGE

For long-term storage, fill the pump with a storage solution made of a 50/50 mix of motor oil and mineral spirits.

To fill the pump:

1. Place both the suction tube and drain tube in a small quantity of storage solution.
2. With the priming valve in the open position, turn the machine on and turn the pressure control knob just enough for the pump to run.
3. Watch the drain tube and as soon as the storage solution appears in the tube, shut the machine off and close the priming valve. This will trap the storage solution inside the pump to protect it.

MAINTENANCE

Every 50 hours of operation blow compressed air through the motor cooling fins to clean out accumulated dust. (If operating in especially dusty conditions, perform this operation more often.)

HOURLY MAINTENANCE

We recommend after every hour of spraying, stop, follow the Pressure Relief Procedure and perform the following:

- **Add about 2 drops of throat Seal Oil to lubricate the packings.**
- **Clean the pump filter.**
- **Clean the gun filter.**
- **Clean the tip.**
- **Clean the inlet strainer as needed.**

CAUTION: Never lay the pump on its back. Material could flow backward and damage the electronics or motor.

DAILY MAINTENANCE

- 1. Keep the displacement pump packing nut lubricated with throat seal oil at all times.** Add about five drops of oil to the top of the pump at the beginning of each day. Then two drops for every hour of spraying. The throat seal oil helps protect the piston, rod and packings.
- 2. Inspect the packing nut daily.** If either of the following conditions exists the packing nut should be tightened:
 - a. Seepage of material past the packing is found.
 - b. While the system is pressurized during the intervals when the motor is not running, the piston doesn't hold its position. Rather, it tends to slip upward.

To tighten the packing nut: First loosen the butterfly bolt 27 and raise the fence 29. Now reach the tommy bar through the opening and tighten the packing nut a small amount. When finished, reclose the fence.

CAUTION: The packing nut should be tightened just enough to stop leakage only, but

not any tighter. Overtightening will damage the packings and reduce packing life.

- 3. Clean the intake check ball and seat.**

TO CLEAN:

1. Remove the intake strainer, suction assembly and check ball housing.
2. Remove the check ball and ball guide and clean all related parts.
3. Replace in the reverse of assembly and tighten.

PUMP PACKINGS

The packings are a wearing part. If the pump can no longer maintain pressure, has difficulty priming and paint seeps into the throat of the pump, and tightening the packing nut no longer helps, then the packings will require replacement. This is best entrusted to a qualified repair technician. To remove the pump and replace the packings, follow the instructions below:

PUMP REMOVAL AND PACKINGS REPLACEMENT

1. Loosen the Check Ball Housing 1 then remove the complete Suction Assembly.
2. Unscrew the high pressure hose (62) from the pump end.
3. Loosen the T-wrench clamp (25) and open the cover of the Pump Carrier Clamp.
4. Slowly rotate the motor so that the piston is at its lowest point and then pull out the Pump Wrist Pin (36).
5. Now rotate the motor so that the piston is at its highest position to release the pump assembly from the Drive Piston (35).
6. The pump assembly may now be lifted away to the workbench for packings renewal.
7. Loosen the Packing Nut (20) and remove.

8. Push the Displacement Piston with the Packing Set Holder out of the Pump Body toward the bottom using a soft-faced mallet.
9. Loosen the Lower Packing Nut 9, withdraw the piston from the Packing Set Holder and remove and discard the old packings. Remove the old O-rings from the Packing Set Holder.
10. Press out the Packing Set Seat 19 and the Intake Disc 3 and remove the old O-rings.
11. After adding new O-rings, lubricate and press in the Packing Set Seat 19 into the pump body and press in the Intake Disc 3 into the Check Ball Housing.
12. Remove the Ball Seat Fastener (12), Small Ball Seat (13) and small Check Ball (14). Then clean all parts.
13. Soak the new leather packings in W30 oil for at least one hour before assembling.
14. Replace the packings, glands, o-rings, springs and check balls with the new parts from the rebuild kit. Strictly follow the exact order and orientation. The packings will be cupped in the direction of the pressure, so the upper packings are cupped downward, the bottom half of the lower packings are cupped downward, and the upper half of the lower packings are cupped in the upward direction. (It's easier to assemble in the smooth direction).
15. Insert the piston with lower packings into the Packing Set Holder. First add blue locktite, then thread on the Lower Packing Nut 9 until resistance is felt. Then tighten a further 3/4 turn.
16. Insert the Piston into the Pump Body from the

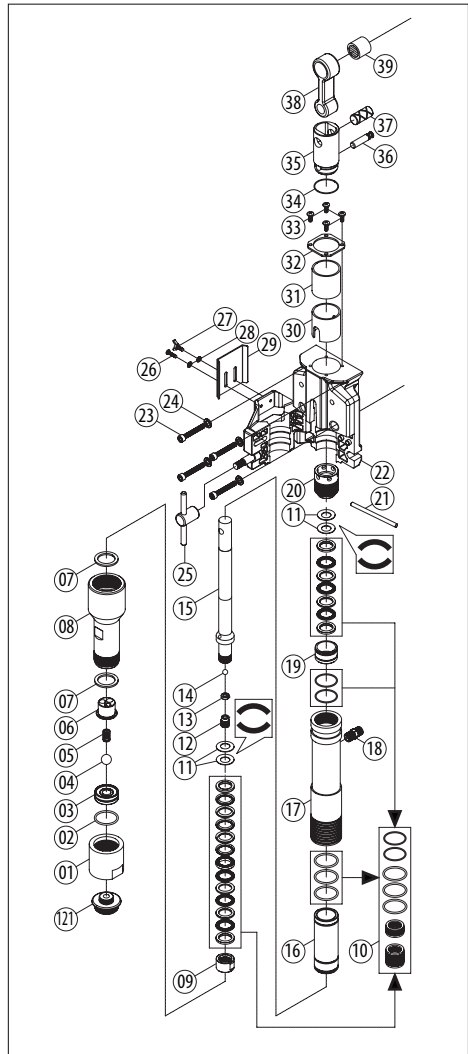

bottom. Then install the upper packings set and disc springs from the top. Thread on the Packing Nut until resistance is felt. Then tighten a further 3/4 turn.

17. Replacement of the pump is the reverse of removal (steps 1~5 above).

MOTOR MAINTENANCE

LUBRICATION – The gear case grease may be changed every 200 hours of operation. This is best entrusted to a qualified repair technician.

If the replacement of the power supply cord is necessary, this has to be done by the manufacturer or their agent in order to avoid a safety hazard.

WARNING: All repairs must be entrusted to an authorized service center. Incorrectly performed repairs could lead to injury or death.

LCD screen error codes:

Error Code	Cause	Effect	How to return to operation	Solution
E5	Pressure sensing abnormality or no signal from sensor	Motor will stop	When pressure signal is normal, will automatically return to operation	Check pressure transducer and check for bad connections with transducer, LCD or PC board
E7	Motor overloaded or electronics board overheated	Motor will stop	Turn the machine OFF and then ON again to reset.	Check motor and wiring. Also check for overtightened packings
E9	Maximum pressure exceeded	Motor will stop	When pressure signal is normal, will automatically return to operation	Check pressure transducer
E61	Voltage below minimum (110V models: under 90V while at rest, under 70V while running) (220V models: under 200V while at rest, under 180V while running)	Motor will stop	When voltage is normal, will automatically return to operation	Check voltage supply
E62	Voltage above maximum (110V models: over 130V) (220V models: over 260V)	Motor will stop	When voltage is normal, will automatically return to operation	Check voltage supply

Troubleshooting

Problem: Motor will not run	
Check	Solution
Electrical supply- must match voltage on machine nameplate	Use correct outlet
Extension cord-check continuity	Replace extension
Power supply cable-check continuity	Replace cable
Carbon brushes	Replace brushes
Bad switch	Replace switch
Motor damage	Replace or repair motor
Problem: Pump loses prime or will not prime	
Check	Solution
Low paint	Refill
Clogged inlet strainer	Clean
Loose suction pipe	Tighten connection
Intake ball not seating	Clean or replace
Problem: Motor cannot turn pump	
Check	Solution
Paint hardened in pump	Replace packings and clean all pump and filter parts
Paint frozen in pump	Thaw pump
Problem: Pressure problems	
Check	Solution
Clogged tip or filter	Relieve pressure and clean
Problem: Motor cannot maintain pressure	
Check	Solution
Oversized tip	Use correct tip for sprayer
Tip worn to become oversize	Relieve pressure and replace tip
Problem:Low output	
Check	Solution
Worn tip	Relieve pressure and replace tip
Worn packings	Replace packings
Filter clogged	Relieve pressure and Clean filter
Priming valve leaking	Relieve pressure and repair valve
Suction pipe leaking or kinked.	Correct kink, or tighten as needed
Low voltage	correct problem, use shorter extension cord.
Pump runs on when trigger is released	Service pump or tighten packing nut
Problem: Motor runs intermittently	
Check	Solution
Pressure set too high for the tip size	Adjust to the correct pressure
Problem: Motor hot and overloaded	
Check	Solution
Packings too tight	Properly adjust packing nut

EXPLODED VIEW

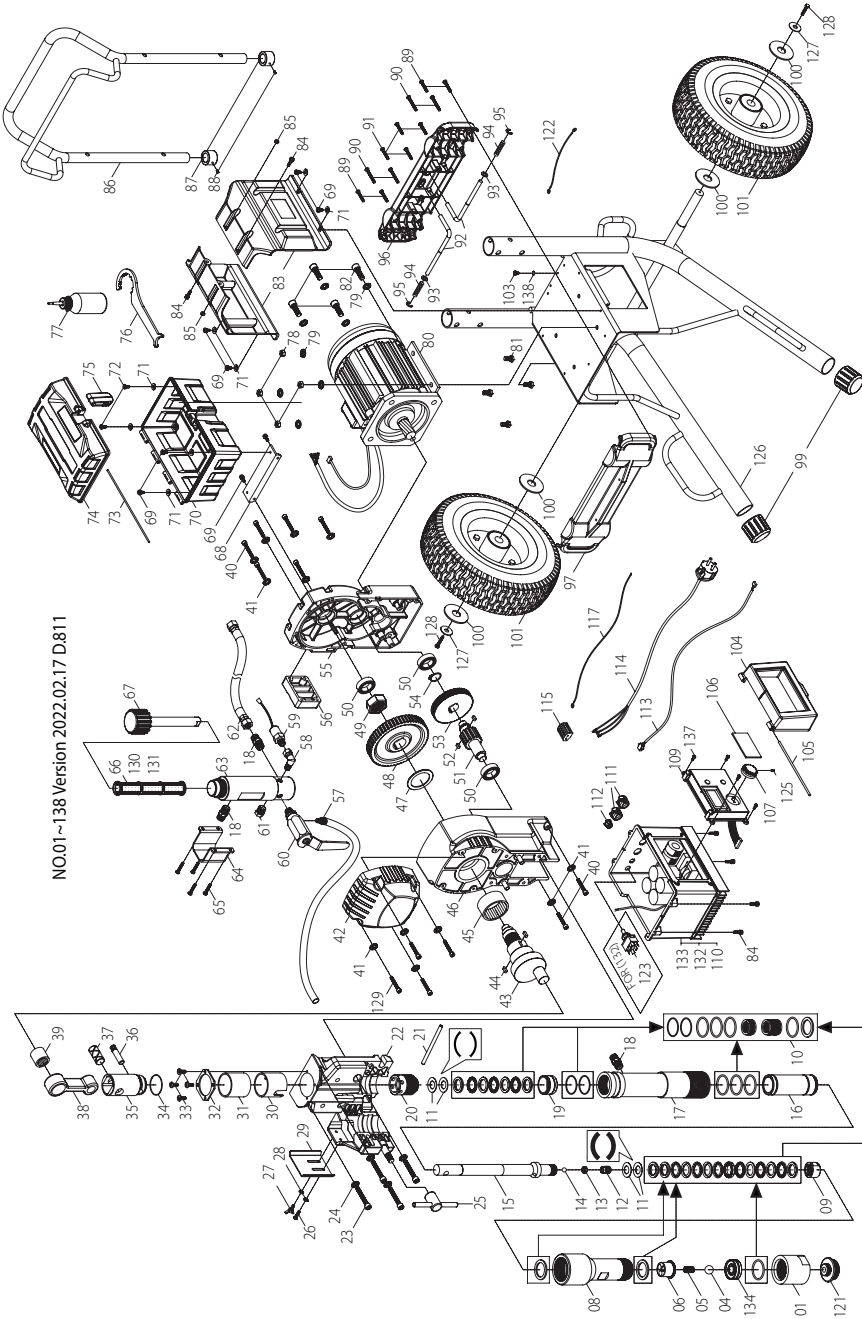

PARTS LIST

NO.	Parts Name	Q'TY	NO.	Parts Name	Q'TY
1	CHECK BALL HOUSING	1	46	GEARCASE	1
4	CHECK BALL (3/4")	1	47	CLUTCH BRASS DISC (Ø46xØ63x2)	1
5	SPRING (Ø0.6xØ12.3xØ13.5xTx20L)	1	48	OUTPUT GEAR (M2.5x54T)	1
6	BALL GUIDE	1	49	CLUTCH NUT (M30xP2.0)	1
8	SUCTION HOUSING	1	50	BALL BEARING (6203)	3
9	INTAKE DISC SEAT (Ø34x12)	1	51	INPUT SHAFT (M2.5x16T)	1
10	PISTON PACKING	1	52	PARALLEL KEY (5x5x12)	2
11	DISC SPRING (Ø25xØ34.7x1)	4	53	INPUT GEAR (M1.5x59T)	1
12	BALL SEAT FASTENER	1	54	EXTERNAL CIRCLIP (S-25)	1
13	BALL SEAT (Ø7xØ15x5)	1	55	GEAR PLATE	1
14	CHECK BALL (3/8")	1	56	MOUNTING BLOCK	1
15	DISPLACEMENT PISTON (295.3L)	1	57	DRAIN TUBE (PT1/4"xØ0.5M)	1
16	PACKING SET HOLDER	1	58	ELBOW FITTING (PT 1/4"-19 x 1/4"-19UNF)	1
17	PUMP HOUSING (242.5L)	1	59	PRESSURE TRANSDUCER (110V&220V)	1
18	OUTPUT NIPPLE (PT 3/8" x 3/8"-19PF)	3	60	PRIMING VALVE	1
19	PACKING SET SEAT (Ø41.5 x 25)	1	61	BOLT (PT 3/8")	1
20	PACKING NUT (M45xP2.0)	1	62	HIGH PRESSURE HOSE (3/8"-19PF)	1
21	PACKING NUT TOMMY BAR	1	63	FILTER HOUSING	1
22	PUMP CARRIER CLAMP	1	64	BRACKET	1
23	SOCKET CAP SCREW (M10x50xP1.5)	4	65	PANHEAD MACHINE SCREW (M5x35xP0.8)	4
24	SPRING WASHER (M10)	4	66	PUMP FILTER (30MESH)	1
25	T-HANDLE BOLT	1	67	FILTER CAP	1
26	PANHEAD MACHINE SCREW (M6x10xP1.0)	1	68	TOOL BOX PLATE	1
27	BUTTERFLY SCREW (M6x10xP1.0)	1	69	PANHEAD MACHINE SCREW (M5x12xP0.8)	8
28	FLAT WASHER (Ø6.5xØ13x1)	2	70	TOOL BOX	1
29	FENCE	1	71	FLAT WASHER (Ø5xØ10x1)	8
30	BUSHING (Ø48xØ54x43)	1	72	PANHEAD TAPPING SCREW (M5x16)	2
31	BUSHING (Ø48xØ54x43)	1	73	HINGE PIN (Ø3x230)	1
32	GUIDE CYLINDER PLATE	1	74	TOOL BOX LID	1
33	TRUSS HEAD MACHINE SCREW (M5x8xP0.8)	4	75	TOOL BOX LOCK	1
34	RETAINING RING (Ø1.5xØ44xØ47)	1	76	DUAL PURPOSE WRENCH	1
35	DRIVE PISTON	1	77	LUBRICATING OIL TANK	1
36	PUMP WRIST PIN (Ø12x52)	1	78	NYLOCK NUT (M10xP1.5)	4
37	PUMP WRIST PIN (Ø20x42)	1	79	SPRING WASHER (M10)	8
38	PISTON/CONNECTING ROD ASSY	1	80	MOTOR UNIT (110V&220V-2.5HP)	1
39	NEEDLE BEARING (TA 2530)	1	81	HEX BOLT (M10x20xP1.5)	4
40	SOCKET CAP SCREW (M6x35xP1.0)	8	82	SOCKET CAP SCREW (M10x25xP1.5)	4
41	SPRING WASHER (M6)	12	83	MOTOR CAP (BLACK)	2
42	GEAR CAP	1	84	PANHEAD MACHINE SCREW (M5x20xP0.8)	6
43	SPINDLE	1	85	HEX NUT (M5xP0.8)	2
44	PARALLEL KEY (5x5x15)	2	86	HANDLE	1
45	NEEDLE BEARING (TA 5530)	1	87	HEAD LOCKING KNOB (Ø22.5xØ32x18)	2

NO.	Parts Name	Q'TY	NO.	Parts Name	Q'TY
88	SOCKET SET SCREW (M4x4xP0.7)	2	112	CABLE GLAND (SB5M-1)	1
89	PANHEAD TAPPING SCREW (M5x25)	4	113	WIRE LEAD	1
90	PANHEAD TAPPING SCREW (M5x40)	4	114	POWER SUPPLY CABLE	1
91	PANHEAD TAPPING SCREW (M5x30)	4	115	5 WIRE PUSH-IN CONNECTOR	1
92	RELEASE LEVER (Ø8x132.9x60)	2	117	EARTH WIRE (Ø3x210MM)	1
93	FLAT WASHER (Ø8xØ16x1.5)	2	121	INLET STRAINER	1
94	SPRING (Ø1.0xØ8.5xØ10.5x9T35L)	2	122	EARTH WIRE (Ø3x120MM)	1
95	E-CLIP (E-7)	2	123	SWITCH-3 POSITION	1
96	CROSSPIECE-REAR	1	125	SOCKET SET SCREW (M4x8xP0.7)	1
97	CROSSPIECE-FRONT	1	126	FRAME	1
99	END CAP	2	127	FLAT WASHER (Ø1/4xØ32x2)	2
100	FLAT WASHER	4	128	HEX BOLT (M6x16xP1.0)	2
101	WHEEL	2	129	SOCKET CAP SCREW (M6x40xP1.0)	4
103	PANHEAD MACHINE SCREW (M5x6xP0.8)	1	130	PUMP FILTER (60MESH)	1
104	CONTROL BOX CAP	1	131	PUMP FILTER (100MESH)	1
105	HINGE PIN (Ø4x175)	1	132	ELECTRONICS UNIT (110V)	1
106	WINDOW (76x42x2)	1	133	ELECTRONICS UNIT (220V)	1
107	SUCTION POWER CONTROL DIAL	1	134	INTAKE DISC	1
109	ELECTRONICS UNIT (110V&220V)	1	137	FLAT HEAD TAPPING SCREW (M4x10)	4
110	ELECTRONICS UNIT (110V)	1	138	EXTERNAL STAR WASHER (M5)	1
111	CABLE GLAND (SB8R-3)(7P-2)	2			

WIRING

