



DM52D Dry Diamond Core Drill Motor

May. 2024

Internal & Confidential

AGP | DM52D Dry Diamond Core Drill Motor

AGP TAIWAN

Lee Yeong Industrial Co., Ltd.

No.2, Kejia Rd., Douliu City, 64057, Taiwan

Tel : 886-5-5518689 Fax : 886-5-5518635

AGP EUROPE BV

Evenbroekveld 16D, 9420 Erpe-Mere, Belgium

Tel : +32 53 21 62 22 Fax : +32 53 83 88 20



Introduction

Target group & Applications

DM52D Introduction

The DM52D is a versatile two-speed dry drilling motor with soft percussion. It is designed for efficient dry drilling of brick and similar materials. Its soft percussion keeps the bit's diamond segments sharp and the integrated dust extraction keeps dust flowing out of the kerf. It uses a 1-1/4" spindle for maximum airflow for the vacuum.

With the optional M16 Dust Extractor, it can also use M16 banana slot type bits.



Target Group & Applications

This tool will be suitable for plumbers, HVAC installers, electricians, and anyone who needs to efficiently dry drill in brick and similar materials.



Sales Arguments



1 **Integrated Dust Extraction**
Collects the dust through the spindle, minimizing dust while cooling the diamond segments.

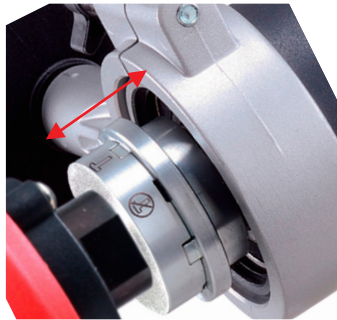

2 **Switchable Soft Percussion**
keeps the diamond segments sharp for more efficient dry drilling. Can be turned off when not needed.



3 **Side Handle**
is inline with the spindle for best control.

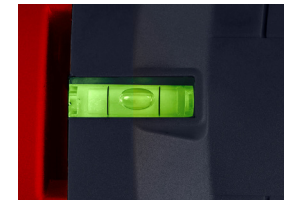

4 **Tubular Spirit Level**
ensures accurate drilling angle.

Sales Arguments

Optional ADD Quick-Release Dry Drilling Equipment

The ADD system allows for quick and tool-free changing of bits with our special bayonet mount coupling. The large orifice allows maximum airflow. The system includes an extension and a centering pilot.

Optional M16 Dry Drilling Equipment

The M16 Dust Extractor works with banana slot type bits which are favored for socket drilling. Externally ventilated M16 bits can use the M16 adaptor. The system also includes a centering pilot suitable for 85 mm length bits.

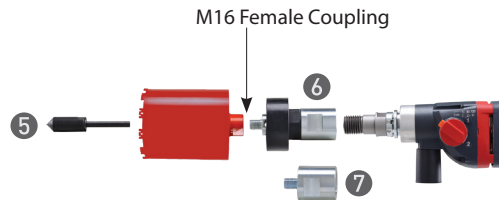
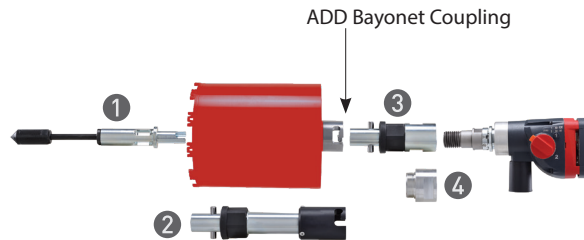

ADD quick release dry drilling equipment			Part Number
①	Centering pilot, ADD		0202-0111-00000-013
②	Extension 200 mm		0299-0114-00000-006
③	ADD quick release		0299-0114-00000-007
④	1-1/4" to ADD M42 Adaptor		301-03022-000-005
Dry Diamond Core Bits with ADD M42 Coupling			Part Number
Diameter(mm)	Coupling	Useful Length(mm)	
56	ADD	200	305-91042-200-056
68	ADD	200	305-91042-200-068
82	ADD	200	305-91042-200-082
102	ADD	200	305-91042-200-102
112	ADD	200	305-91042-200-112
132	ADD	200	305-91042-200-132
162	ADD	200	305-91042-200-162
172	ADD	200	305-91042-200-172
182	ADD	200	305-91042-200-182
M16 dry drilling equipment			Part Number
⑤	Centering Pilot		0202-0111-00000-008
⑥	M16 Dust Extractor (for banana slot bits)		0299-0114-00000-008
⑦	1-1/4" to M16 Adaptor		301-03022-000-005
Dry Diamond Core Bits with M16 Coupling			Part Number
Diameter(mm)	Coupling	Useful Length(mm)	
68	M16	85	305-91016-085-068
82	M16	85	305-91016-085-082
102	M16	85	305-91016-085-102
112	M16	85	305-91016-085-112

Technical Specifications

Model	DM52D
Power Input	1800 W
Voltage, Frequency	220-240 V~ 50-60 Hz or 110-120 V~ 50-60 Hz
No Load (Rated Load) Speeds	Gear 1 1800 (1080) min ⁻¹ Gear 2 3600 (2160) min ⁻¹
Percussion Frequency, No Load (Rated Load)	Gear 1 29,000 (18,850) b/min ⁻¹ Gear 2 56,000 (36,400) b/min ⁻¹
Spindle Thread	1-1/4" UNC male & 1/2" BSP female
Capacity-Dry	182 mm (7-1/4")
Soft Start & Overload Protection	With
Mechanical Safety Clutch	With
Protection Class	Class II
Neck Diameter	60 mm
Dimensions (LxWxH)	505 x 105 x 210 mm
Weight	4.9 kg (10.8 lb)



- 1 Side Handle
- 2 Lock Screw (Side Handle)
- 3 Release Button
- 4 Tubular Spirit Level
- 5 Trigger Switch
- 6 Lock Button
- 7 Spindle
- 8 Percussion Selector
- 9 Gear Selector
- 10 Motor
- 11 Power Supply Cable
- 12 Main Handle
- 13 Hammer Symbol (Percussion On)
- 14 No Hammer Symbol (Percussion Off)

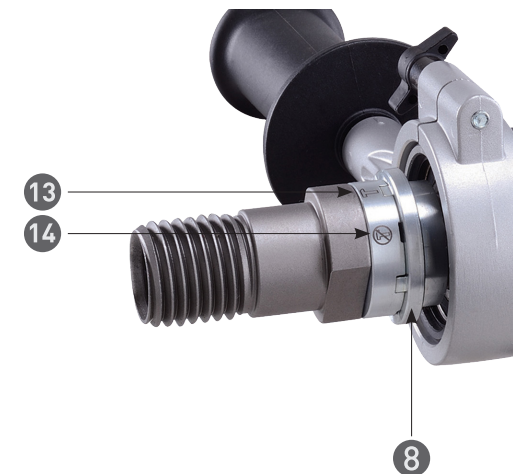

Offer Content

Standard Accessories

- ① DM52D Dry Diamond Core Drill Motor
- ② Side Handle







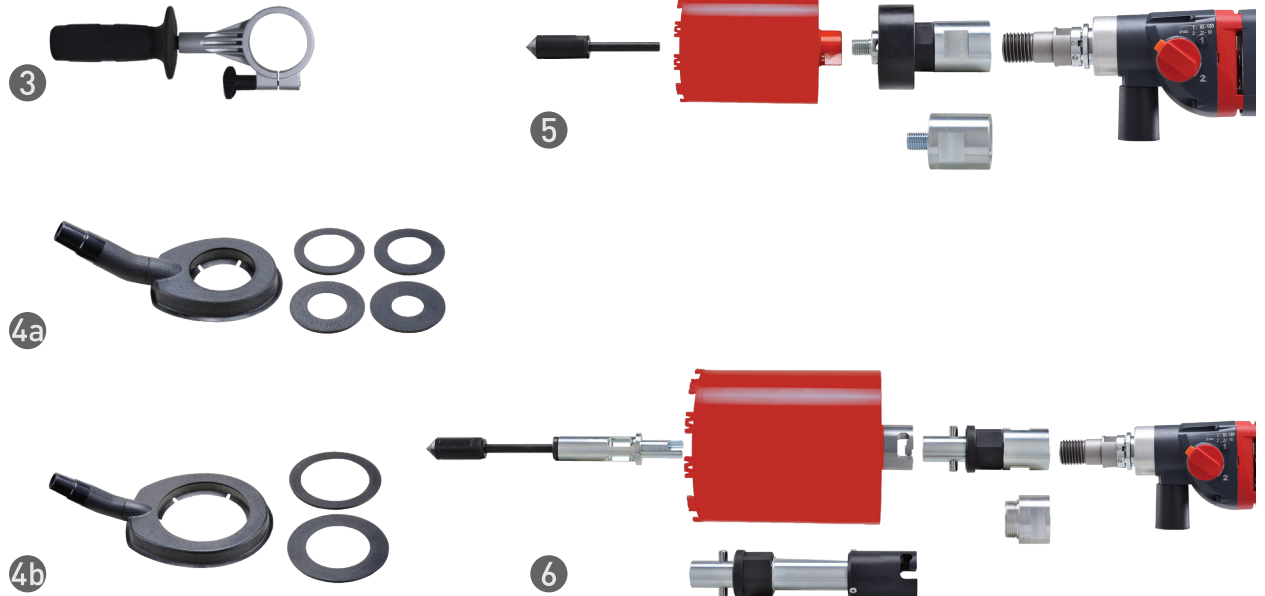











Optional Accessories

- ③ Soft Grip Side Handle
- ④a Vacuum Collector Pad (Small up to 75 mm)
- ④b Vacuum Collector Pad (large up to 130 mm)
- ⑤ M16 Dry Drilling Equipment
- ⑥ ADD Quick-Release Dry Drilling Equipment



Comparison Table

Brand						
General Dry Drilling in Brick						
Model	DM52D	DB1500-2XE	DD2-160XE	BDB 823 A	EHD 2000 S	P 2000 MS13
Power	220-240 V: 1800 W	220-240 V: 1510 W	220-240 V: 1510 W	220-240 V: 1800 W	220-240 V: 1700 W	220-240 V: 2000 W
RPM (rated load)	Gear 1: 1080 /min Gear 2: 2160 /min	Gear 1: 0~890 /min Gear 2: 0~1770 /min	Gear 1: 0~890 /min Gear 2: 0~1770 /min	1650 /min	Gear 1: 0~1000 /min Gear 2: 0~2000 /min	1350 /min
Percussion Frequency (rated load)	Gear 1: 18 850 b/min Gear 2: 36 400 b/min	Gear 1: 24 000 bpm Gear 2: 48 000 bpm	Gear 1: 24 000 b/min Gear 2: 48 000 b/min	33 000 b/min	N/A	34 000 b/min
Capacity-Dry	182 mm 	162 mm	162 mm	150 mm	132 mm	162 mm
Spindle	1-1/4" UNC male & 1/2" BSP female	M18-2.5	M18-2.5	M18-2.5	M18-2.5	M18-2.5
Switchable Percussion	YES	YES	YES	YES	NO	YES
2 Speed Gearbox	YES 	YES	YES	NO	YES	NO
Blowcase	YES	YES	YES	YES	YES	YES
Anti-Vibration Side Handle	Optional 	YES	YES	NO	NO	NO
Built-in Level	YES 	NO	NO	YES	NO	NO
Variable Speed Switch	NO	YES	YES	NO	YES	NO
Weight	5 kg	4.2 kg	4.2 kg	5.2 kg	5.5 kg	4.8 kg
Dust Collector Description	For 1-1/4" thread unventilated bits	Not Available	For 1-1/4" thread, unventilated bits only. No limitation on length.	For M16 thread, short socket bits with side vents only.	For M16 thread, short socket bits with banana slot vents only, 1-1/4" bits not limited on length.	For 1-1/4" thread, unventilated bits only. No M16 dust collector sold.
Centering Aid	Optional	Not Available	Optional	Optional	Optional	Optional
Dust Collector Thread	Optional M16	Not Available	M18- 1-1/4"	M18-M16	M18-M16 M18- 1-1/4"	M18- 1-1/4"
Conclusion	The AGP brings together all the features for the ideal dry drill, with the power, percussion, ideal rpm, level, and centering aid to allow optimal drilling. The AGP external dustextractor is uniquely convenient with its access door for easy bit changes.					

Tool Dimensions

